



**TRS**  
SOLUTIONS

# SITE SECURITY

• virtualize • verify • vault

# From V-Turnstile to V-Alert: Discover the latest and most advanced security technologies.



## Turnstiles

- V-Turnstile
- V-Turnstile-Steelplate
- V-Turnstile-Fix
- V-Turnstile-Guard
- V-Turnstile-Compact
- V-Turnstile-Compact-Steelplate
- V-Turnstile-Compact-Fix
- V-Turnstile-Compact-Guard
- V-Turnstile-Bike-Steelplate
- V-Turnstile-Duo-Steelplate
- V-Turnstile-Hip

page 6 - 29



## Security systems

- V-Alert
- V-Post

page 64 - 67



## Gates

- V-Gate-Simple
- V-Gate-Simple-5.5
- V-Fold-Steelplate

page 30 - 35



## Room systems

- V-Lounge
- V-Office
- V-Space
- V-Guard

page 68 - 77



## Doors

- V-Door
- V-Door-Steelplate
- V-Door-Fix
- V-Door-Compact
- V-Door-Compact-Steelplate
- V-Door-Compact-Fix

page 36 - 49



## Extensions

- V-Plattform
- V-Ramp

page 78 - 79

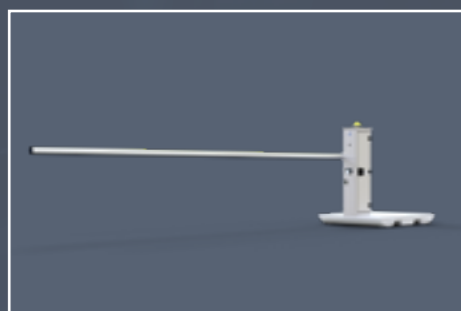

## Barriers

- V-Barrier-5m
- V-Barrier-5m-Fix
- V-Barrier-7m
- V-Barrier-7m-Fix

page 50 - 59



## Software

- V-Connect
- V-Access-B

page 80 - 83



## Registration systems

- V-Control
- V-Control-Fix
- V-Control-Long
- V-Control-Long-Fix
- V-Control-Clock

page 60 - 63

# Vector: Modern design, maximum security.

# Modern security systems for every application.

With the flexible product solutions from the Vector-series, we rely on state-of-the-art technologies combined with contemporary design to ensure security on your premises. Whether in mobile or permanent applications, our goal is always to create "plug-and-play" solutions that simplify your processes and close security gaps through hardware and software!

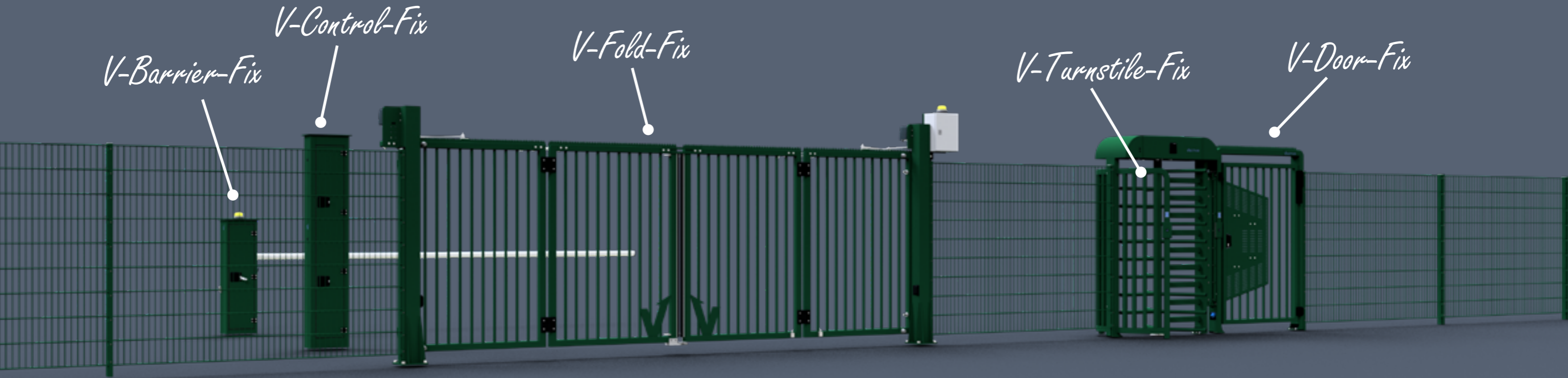

*V-Barrier-Fix*

*V-Control-Fix*

*V-Fold-Fix*

*V-Turnstile-Fix*

*V-Door-Fix*

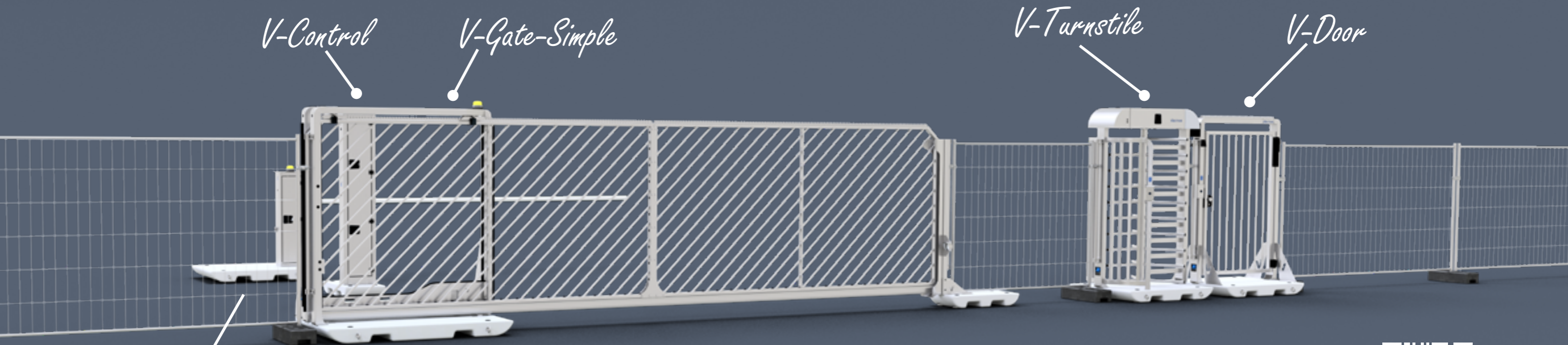

*V-Control*

*V-Gate-Simple*

*V-Turnstile*

*V-Door*

*V-Barrier*

*for more information*



# Customized, modern, functional. Security redefined.

## Durable and secure – modular turnstile systems for flexible access control.

Our turnstiles offer maximum versatility: various passage widths, a modular design and a robust construction make them ideal for construction sites, events, or permanent security installations. Thanks to integrated forklift pockets and crane eyes, they can be easily relocated and flexibly deployed – whether mobile or permanent.

With options for different sizes, weights and passage widths, they meet a wide range of security requirements. They support various access control systems, from RFID and fingerprint readers to mechanical profile cylinders. The locking direction can be adjusted and in the event of a power failure, they can operate in either fail-open or fail-close mode, as required.

Equipped with service-friendly access panels, electromechanical control units and optional powder coating in selectable colors, our systems stand out for their durable quality, intuitive operation and high-end technology.

### Proven in harsh environments.

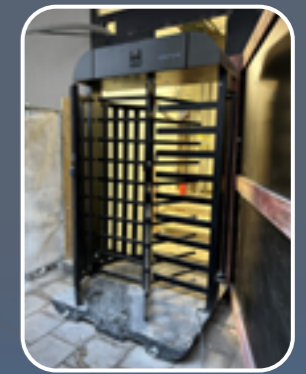

# V-Turnstile

## High-quality access control – precise, durable and mobile.

In the world of construction and event security, safety comes first. Our wide range of innovative security solutions is designed to meet your specific requirements.

Discover the **V-Turnstile** – a versatile mobile turnstile for construction sites and events. With dimensions of 2.00 x 1.93 x 2.42 m and a weight of 1310 kg, it offers solid security combined with mobility. The 0.85 m passage width ensures a smooth flow of people while still allowing light luggage to pass through the turnstile.

The **V-Turnstile** can be equipped with various access control systems and features adjustable locking directions via profile cylinders. In the event of a power failure, the exit remains freely rotatable. Experience the perfect combination of security, flexibility, and user-friendliness for your construction and event requirements with the **V-Turnstile**.

### Outstanding features: Discover the highlights of the V-Turnstile:

- ✓ Dimensions: 2.00 x 1.93 x 2.42 m
- ✓ Weight: 1310 kg
- ✓ Passage width: 0.85 m
- ✓ On mobile concrete platform with adjustable feet
- ✓ Suitable for outdoor use
- ✓ Connection via 230 V CEE plug
- ✓ 24 V (electro)mechanical control unit
- ✓ Adjustable relay holding times
- ✓ Profile cylinder for mechanical opening/closing
- ✓ Robust and durable bearings + shafts
- ✓ Lockable service flap
- ✓ Adjustable damping on the control unit
- ✓ Fail-open, fail-close module
- ✓ Connection of access controls possible on both sides
- ✓ Flexible fence connection
- ✓ Individual powder coating

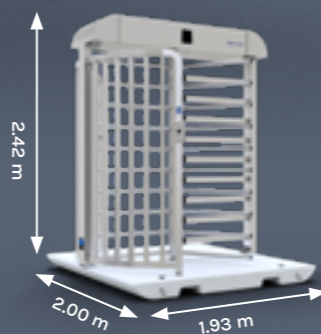
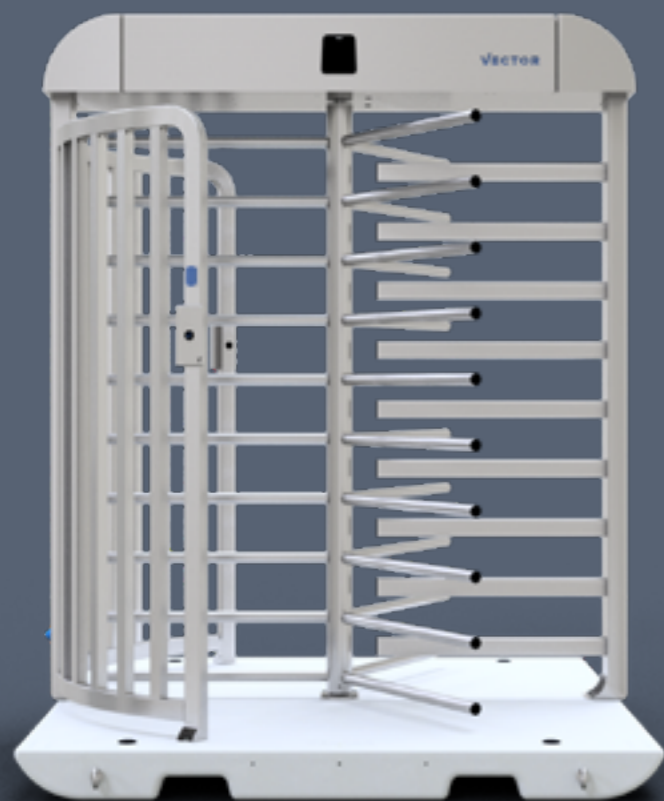

Product group	Item description	Part-No.	kg
Turnstile	V-Turnstile-Basic	VPDRB	1310.00
Turnstile	V-Turnstile	VPDR	1310.00

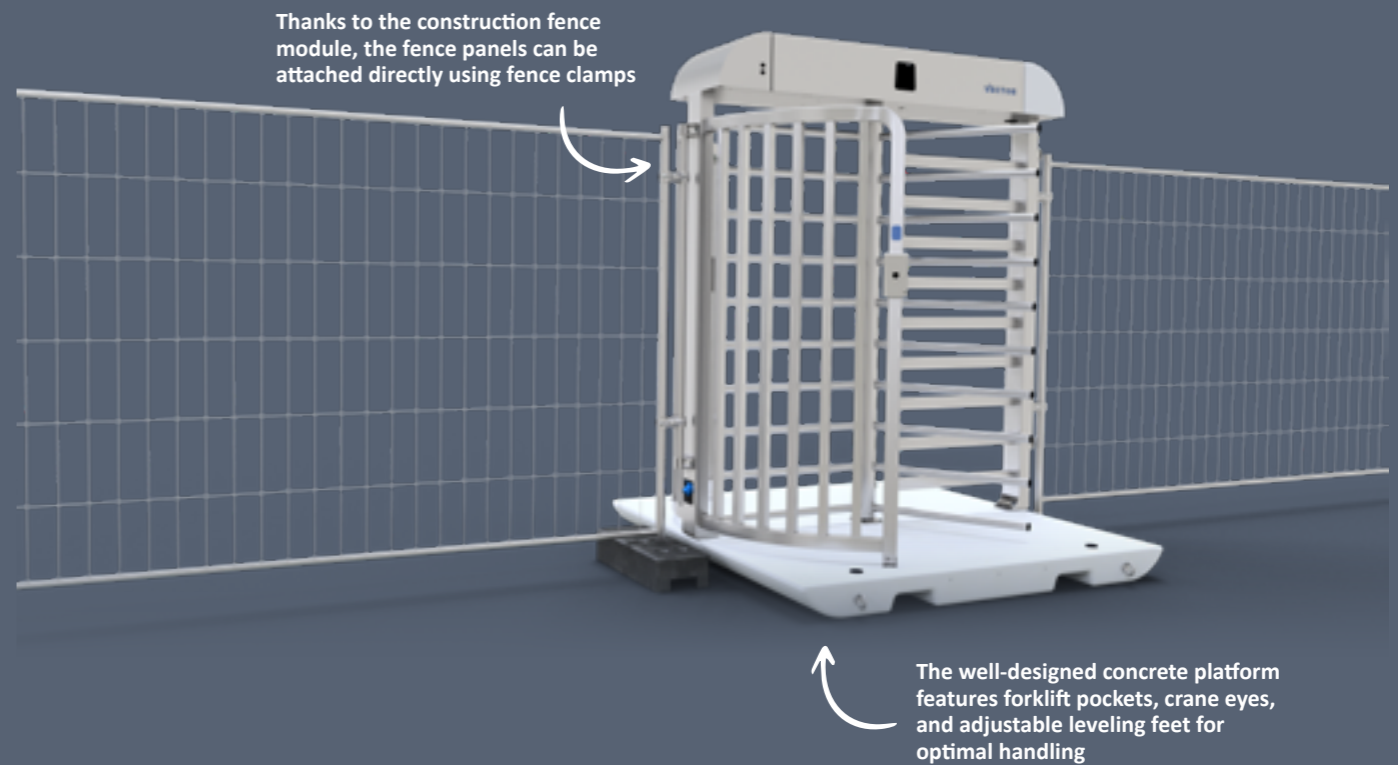

Accessories	Item description	Part-No.	kg
Medium surface finish	RAL colour of choice - size M	VRALW-M	
Fence connection	2x site fence module	VZPBZ	8.00
Fence connection	Assembly 2x site fence module	VZPBZ-M	
Fence connection	2x double wire mesh fence module	VZPDZ	14.00
Fence connection	Assembly 2x double picket fence module	VZPDZ-M	
Access control	one-sided local reader	VZZZKE	0.47
Access control	Mounting one-sided local reader	VZZZKE-M	
Access control	RFID chip for local RFID access control	VZZCHIPL	0.01
Access control	Access control with 2 readers	VB-ZUKO2	5.00
Access control	Mounting access control with 2 readers	VB-ZUKO2-M	
Access control	Wiring customer access system	VZIWIRE	
Turnstile accessories	LED with pictogram on both sides	VZDLED	0.80
Turnstile accessories	Mounting double-sided LED with pictogram	VZDLED-M	
Turnstile accessories	LED Components	VZELED	0.80
Turnstile accessories	Installation LED Components	VZELED-M	
Turnstile accessories	Adapter plate incl. emergency stop switch	VZDNOTA	0.06
Turnstile accessories	Mounting adapter plate incl. emergency stop switch	VZDNOTA-M	
Turnstile accessories	Control unit, electromechanical	VZDSTE	15.00
Turnstile accessories	Control unit, mechanical	VZDSTM	15.00
Turnstile accessories	Ball bearing	VZDKUG	0.09
Turnstile accessories	Turnstile floor anchoring (milled part)	VZDFRB	1.87
Turnstile accessories	Gas pressure damper for small bonnet	VZRGDK	0.25

# Access with character: For projects that leave a lasting impression.

The **V-Turnstile-Steelplate** combines modern security technology with maximum flexibility. This electromechanical turnstile is mounted on a stable mobile steel plate and is ideally suited for use on construction sites, at events, or in temporary installations.

With its compact dimensions of 2.00 × 1.93 × 2.27 m, a weight of 628 kg and a passage width of 0,85 m, it provides reliable access control while remaining easy to transport.

The galvanized steel frame ensures durability and corrosion resistance, while the electromechanical control system guarantees a regulated flow of people.

Whether used as a standalone module or combined with additional access solutions, the **V-Turnstile-Steelplate** represents functional security, mobility and modern design – in line with the Vector philosophy: virtualize, verify, vault.



**Outstanding features: Discover the highlights of the V-Turnstile-Steelplate:**

- ✓ Dimensions: 2.00 x 1.93 x 2.27 m
- ✓ Weight: 628 kg
- ✓ Passage width: 0.85 m
- ✓ On mobile steel plate
- ✓ Suitable for outdoor use
- ✓ Connection via 230 V CEE plug
- ✓ 24 V (electro)mechanical control unit
- ✓ Adjustable relay holding times
- ✓ Profile cylinder for mechanical opening/closing
- ✓ Robust and durable bearings + shafts
- ✓ Lockable service flap
- ✓ Adjustable damping on the control unit
- ✓ Fail-open, fail-close module
- ✓ Access control can be connected on both sides
- ✓ Flexible fence connection
- ✓ Custom powder coating

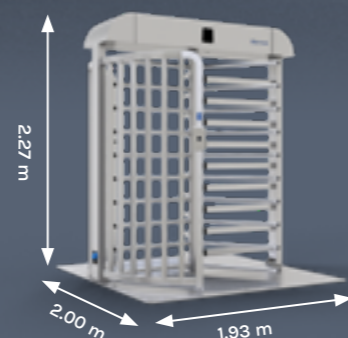

Product group	Item description	Part-No.	kg
Turnstile	V-Turnstile-Steelplate-Basic	VPDRSB	628.00
Turnstile	V-Turnstile-Steelplate	VPDRS	628.00

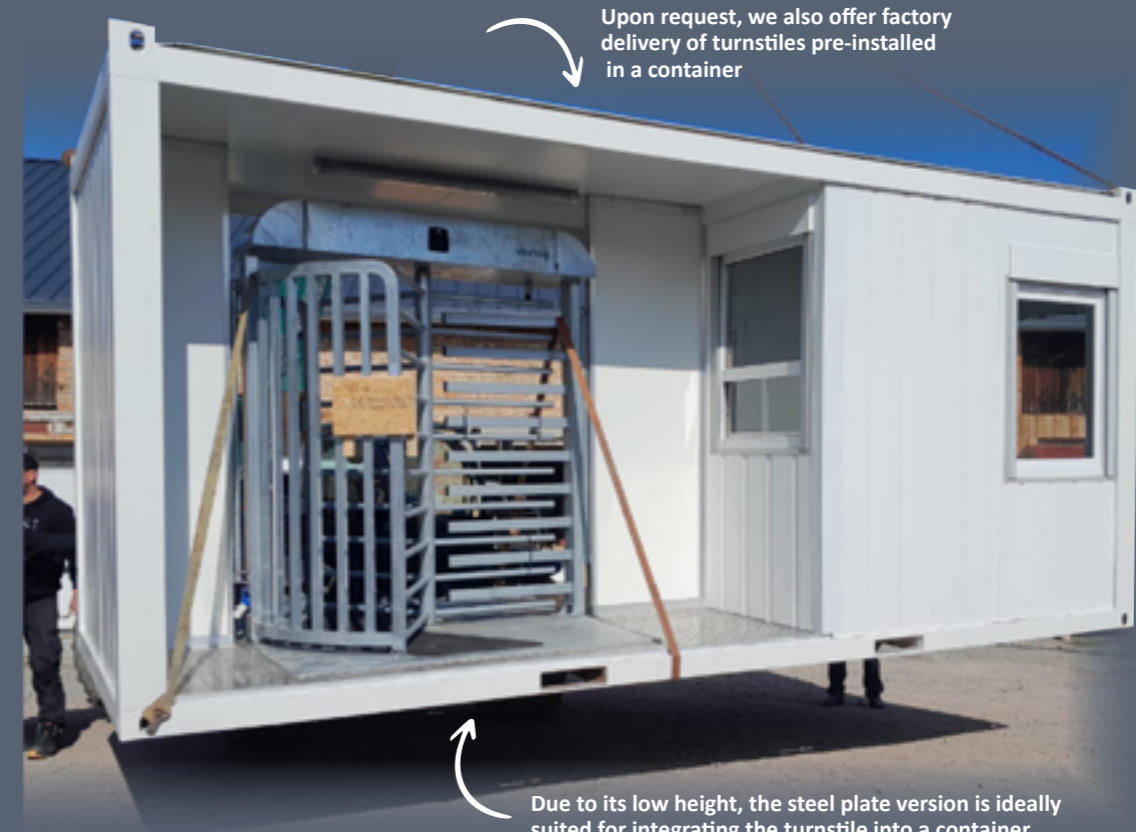

Accessories	Item description	Part-No.	kg
Medium surface finish	RAL colour of choice - size M	VRALW-M	
Fence connection	2x site fence module	VZPBZ	8.00
Fence connection	Assembly 2x site fence module	VZPBZ-M	
Fence connection	2x double wire mesh fence module	VZPDZ	14.00
Fence connection	Assembly 2x double picket fence module	VZPDZ-M	
Access control	one-sided local reader	VZZZKE	0.47
Access control	Mounting one-sided local reader	VZZZKE-M	
Access control	RFID chip for local RFID access control	VZZCHIPL	0.01
Access control	Access control with 2 readers	VB-ZUKO2	5.00
Access control	Mounting access control with 2 readers	VB-ZUKO2-M	
Access control	Wiring customer access system	VZIWIRE	
Turnstile accessories	LED with pictogram on both sides	VZDLED	0.80
Turnstile accessories	Mounting double-sided LED with pictogram	VZDLED-M	
Turnstile accessories	LED Components	VZELED	0.80
Turnstile accessories	Installation LED Components	VZELED-M	
Turnstile accessories	Adapter plate incl. emergency stop switch	VZDNOTA	0.06
Turnstile accessories	Mounting adapter plate incl. emergency stop switch	VZDNOTA-M	
Turnstile accessories	Control unit, electromechanical	VZDSTE	15.00
Turnstile accessories	Control unit, mechanical	VZDSTM	15.00
Turnstile accessories	Ball bearing	VZDKUG	0.09
Turnstile accessories	Turnstile floor anchoring (milled part)	VZDFRB	1.87
Turnstile accessories	Gas pressure damper for small bonnet	VZRGDK	0.25

# For places that deserve protection: Security, firmly anchored.

The V-Turnstile-Fix stands for reliable access control with a solid foundation. Manufactured from galvanized steel and mounted on a stable steel plate, it impresses with durable quality and a clean, modern design.

Whether on construction sites, event grounds, or in sensitive operational areas, the turnstile ensures orderly processes and a secure feeling at the point of entry. Its compact design and smooth passage make it the ideal solution for projects that prioritize security, stability and style.



### Outstanding features: Discover the highlights of the V-Turnstile-Fix:

- ✓ Dimensions: 1.80 x 1.93 x 2.27 mm
- ✓ Weight: 333 kg
- ✓ Passage width: 0,85 m
- ✓ On steel plate for doweling
- ✓ Suitable for outdoor use
- ✓ Connection via 230 V CEE plug
- ✓ 24 V (electro)mechanical control unit
- ✓ Electromechanical control unit
- ✓ Profile cylinder for mechanical opening/closing
- ✓ Robust and durable bearings + shafts
- ✓ Lockable service flap
- ✓ Adjustable damping on the control unit
- ✓ Access control can be connected on both sides
- ✓ Flexible fence connection
- ✓ Custom powder coating

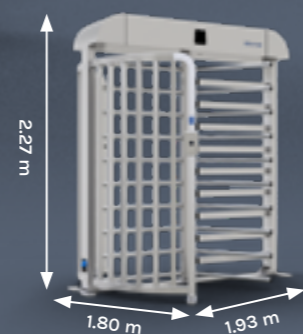

Product group	Item description	Part-No.	kg
Turnstile	V-Turnstile-Fix-Basic	VPDRFB	333.00
Turnstile	V-Turnstile-Fix	VPDRF	333.00

Full-height turnstiles are also ideally suited for indoor use to prevent people from climbing over access control points



The fixed versions can be bolted directly to the ground and are therefore designed for permanent installations

Accessories	Item description	Part-No.	kg
Medium surface finish	RAL colour of choice - size M	VRALW-M	
Fence connection	2x site fence module	VZPBZ	8.00
Fence connection	Assembly 2x site fence module	VZPBZ-M	
Fence connection	2x double wire mesh fence module	VZPDZ	14.00
Fence connection	Assembly 2x double picket fence module	VZPDZ-M	
Access control	one-sided local reader	VZZZKE	0.47
Access control	Mounting one-sided local reader	VZZZKE-M	
Access control	RFID chip for local RFID access control	VZZCHIPL	0.01
Access control	Access control with 2 readers	VB-ZUKO2	5.00
Access control	Mounting access control with 2 readers	VB-ZUKO2-M	
Access control	Wiring customer access system	VZIWIRE	
Turnstile accessories	LED with pictogram on both sides	VZDLED	0.80
Turnstile accessories	Mounting double-sided LED with pictogram	VZDLED-M	
Turnstile accessories	LED Components	VZELED	0.80
Turnstile accessories	Installation LED Components	VZELED-M	
Turnstile accessories	Adapter plate incl. emergency stop switch	VZDNOTA	0.06
Turnstile accessories	Mounting adapter plate incl. emergency stop switch	VZDNOTA-M	
Turnstile accessories	Control unit, electromechanical	VZDSTE	15.00
Turnstile accessories	Control unit, mechanical	VZDSTM	15.00
Turnstile accessories	Ball bearing	VZDKUG	0.09
Turnstile accessories	Turnstile floor anchoring (milled part)	VZDFRB	1.87
Turnstile accessories	Gas pressure damper for small bonnet	VZRGDK	0.25

# Efficient construction, stylish events: Discover our forward-thinking solutions.

The **V-Turnstile-Guard** is a mobile turnstile tunnel that can be integrated at any desired position within a V-Guard system, thereby extending the same protection principle of the V-Guard to pedestrians in various environments.

The **V-Turnstile-Guard** can be equipped with a wide range of access control systems. The locking direction can be adjusted via a profile cylinder. As standard, it is freely rotatable in one direction in the event of a power failure.

It includes a CEE plug, LED lighting at the front and rear controlled by a motion sensor, an electromechanical control unit and a service hatch.



### Outstanding features: Discover the highlights of this V-Turnstile-Guard:

- ✓ Dimensions: 2.00 x 1.93 x 2.42 m
- ✓ Weight: 1740 kg
- ✓ Passage width: 0.85 m
- ✓ On mobile concrete platform with adjustable feet
- ✓ Suitable for outdoor use
- ✓ Connection via 230 V CEE plug
- ✓ 24 V (electro)mechanical control unit
- ✓ Electromechanical control unit
- ✓ Profile cylinder for mechanical opening/closing
- ✓ Robust and durable bearings + shafts
- ✓ Lockable service flap
- ✓ Adjustable damping on the control unit
- ✓ Steel protective walls
- ✓ Access control can be connected on both sides
- ✓ Flexible fence connection
- ✓ Custom powder coating

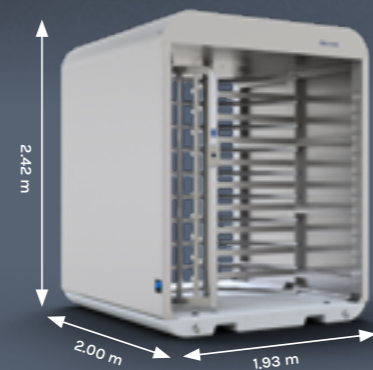

Product group	Item description	Part-No.	kg
Turnstile Guard	V-Turnstile-Guard-Basic	VPDTB	1740.00
Turnstile Guard	V-Turnstile-Guard	VPDT	1740.00

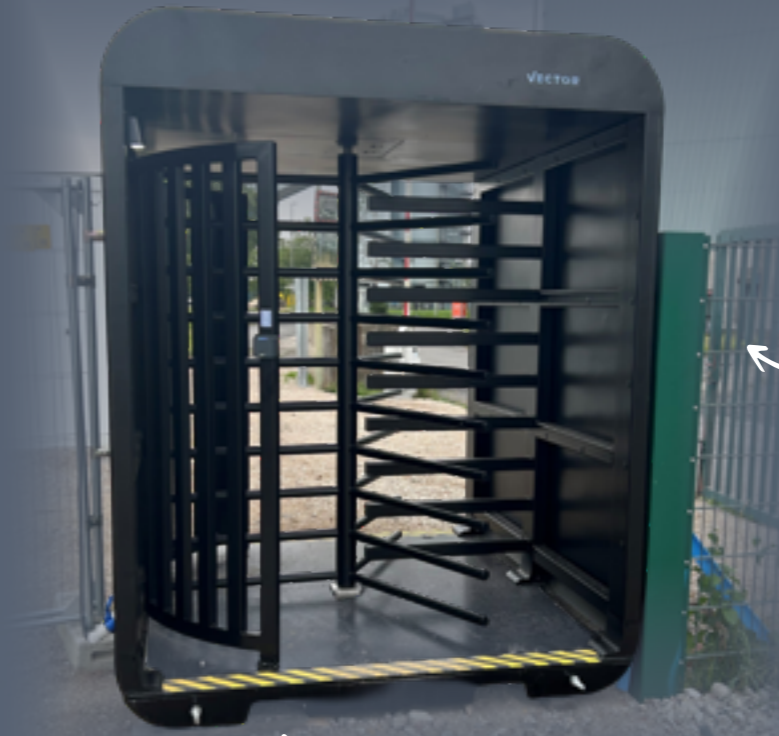

The adapter plate integrated as standard ensures that a wide range of reader designs can be mounted directly

The leveling feet can also be adjusted from above while the unit is in position, ensuring a secure and stable setup in no time

Accessories	Item description	Part-No.	kg
Large surface finish	RAL colour of choice - size L	VRALW-L	
Fence connection	2x site fence module	VZPBZ	8.00
Fence connection	Assembly 2x site fence module	VZPBZ-M	
Fence connection	2x double wire mesh fence module	VZPDZ	14.00
Fence connection	Assembly 2x double picket fence module	VZPDZ-M	
Access control	one-sided local reader	VZZZKE	0.47
Access control	Mounting one-sided local reader	VZZZKE-M	
Access control	RFID chip for local RFID access control	VZZCHIPL	0.01
Access control	Access control with 2 readers	VB-ZUKO2	5.00
Access control	Mounting access control with 2 readers	VB-ZUKO2-M	
Access control	Wiring customer access system	VZIWIRE	
Turnstile accessories	LED with pictogram on both sides	VZDLED	0.08
Turnstile accessories	Mounting double-sided LED with pictogram	VZDLED-M	
Turnstile accessories	Adapter plate incl. emergency stop switch	VZDNOTA	0.06
Turnstile accessories	Mounting adapter plate incl. emergency stop switch	VZDNOTA-M	
Turnstile accessories	Control unit, electromechanical	VZDSTE	15.00
Turnstile accessories	Control unit, mechanical	VZDSTM	15.00
Turnstile accessories	Ball bearing	VZDKUG	0.09
Turnstile accessories	Turnstile floor anchoring (milled part)	VZDFRB	1.87
Accessories for room systems	Gas pressure damper for small bonnet	VZRGDK	0.25

# Efficient single-person access control: The V-Turnstile-Compact – the smart choice for mobile access control.

The **V-Turnstile-Compact** is more than just a mobile turnstile. With its slim passage width, it is the perfect choice for construction sites and events where security and efficiency are top priorities. And that's just the beginning of its versatility. Thanks to integrated forklift pockets and crane eyes, it can be easily relocated and used both as a mobile and stationary solution.

With dimensions of 1.20 x 1.43 x 2.42 m and a weight of 736 kg, the **V-Turnstile-Compact** is compact yet robust. Up to 18 **V-Turnstile-Compact** units can be loaded onto a single semi-trailer. Its narrow passage width ensures precise and efficient single-person access control, while the option to integrate a wide range of access control systems meets individual security requirements.

But that's not all: the locking direction can be adjusted via a profile cylinder and as standard, the **V-Turnstile-Compact** is freely rotatable in one direction in the event of a power failure. Equipped with a CEE plug, an electromechanical control unit, and a practical service hatch, it is the ideal solution for modern security applications.

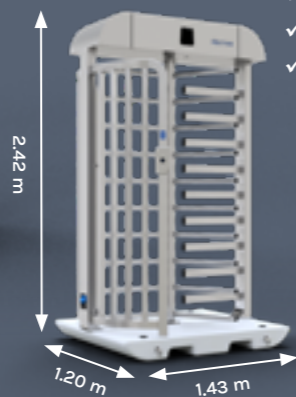
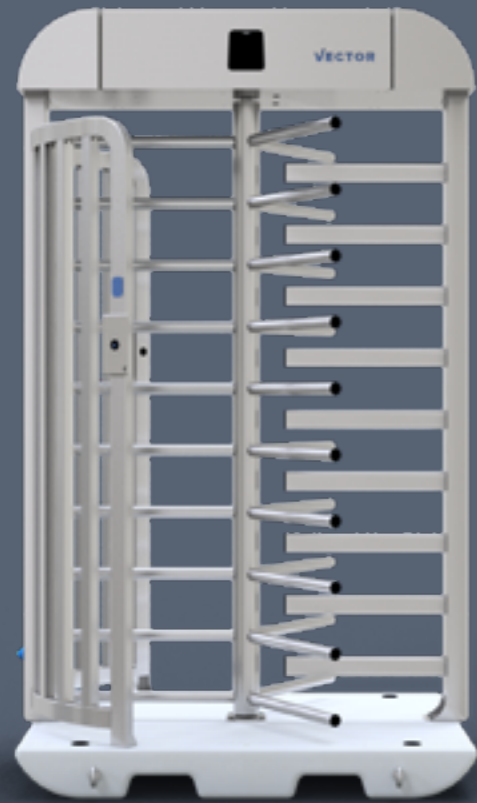

### Outstanding features: Discover the highlights of the V-Turnstile-Compact:

- ✓ Dimensions: 1.20 x 1.43 x 2.42 m
- ✓ Weight: 736 kg
- ✓ Passage width: 0,6 m
- ✓ On mobile concrete platform with adjustable feet
- ✓ Suitable for outdoor use
- ✓ Connection via 230 V CEE plug
- ✓ 24 V (electro)mechanical control unit
- ✓ Electromechanical control unit
- ✓ Profile cylinder for mechanical opening/closing
- ✓ Robust and durable bearings + shafts
- ✓ Lockable service flap
- ✓ Adjustable damping on the control unit
- ✓ Access control can be connected on both sides
- ✓ Flexible fence connection
- ✓ Custom powder coating

Product group	Item description	Part-No.	kg
Turnstile Compact	V-Turnstile-Compact-Basic	VPDKB	736.00
Turnstile Compact	V-Turnstile-Compact	VPDK	736.00

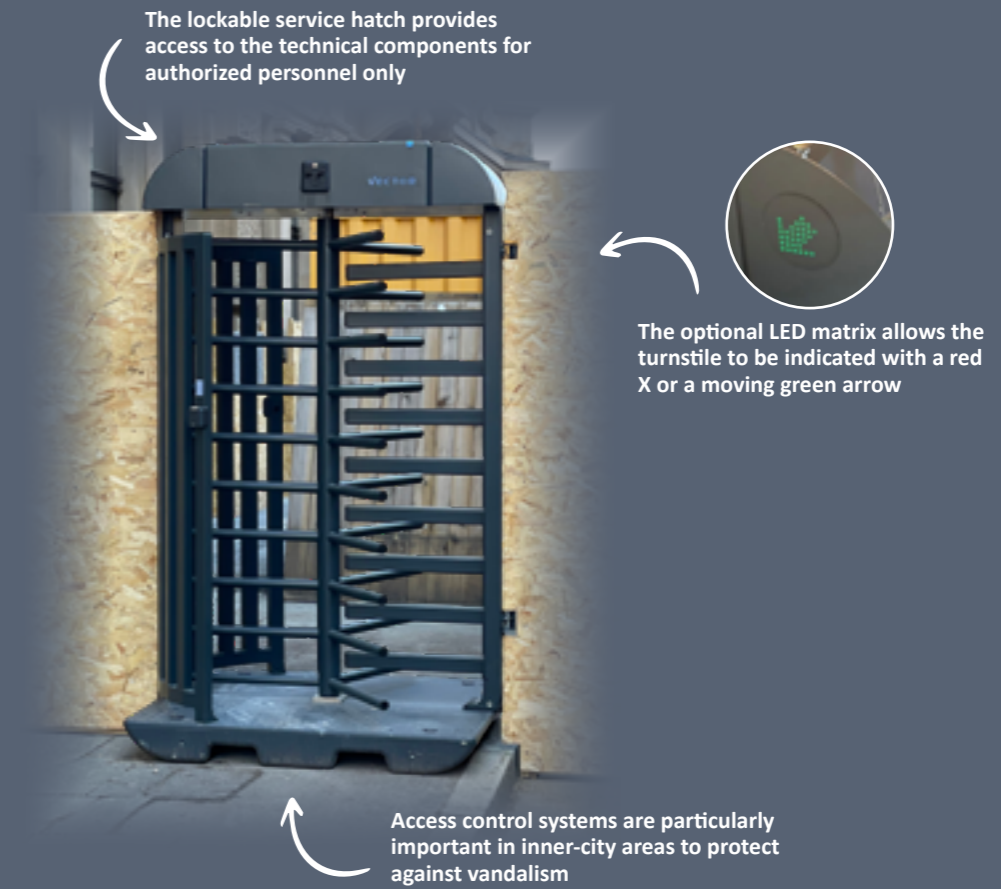

The lockable service hatch provides access to the technical components for authorized personnel only

The optional LED matrix allows the turnstile to be indicated with a red X or a moving green arrow

Access control systems are particularly important in inner-city areas to protect against vandalism

Accessories	Item description	Part-No.	kg
Medium surface finish	RAL colour of choice - size M	VRALW-M	
Fence connection	2x site fence module	VZPBZ	8.00
Fence connection	Assembly 2x site fence module	VZPBZ-M	
Fence connection	2x double wire mesh fence module	VZPDZ	14.00
Fence connection	Assembly 2x double picket fence module	VZPDZ-M	
Access control	one-sided local reader	VZZZKE	0.47
Access control	Mounting one-sided local reader	VZZZKE-M	
Access control	RFID chip for local RFID access control	VZZCHIPL	0.01
Access control	Access control with 2 readers	VB-ZUKO2	5.00
Access control	Mounting access control with 2 readers	VB-ZUKO2-M	
Access control	Wiring customer access system	VZIWIRE	
Turnstile accessories	LED with pictogram on both sides	VZDLED	0.80
Turnstile accessories	Mounting double-sided LED with pictogram	VZDLED-M	
Turnstile accessories	LED Components	VZELED	0.80
Turnstile accessories	Installation LED Components	VZELED-M	
Turnstile accessories	Adapter plate incl. emergency stop switch	VZDNOTA	0.06
Turnstile accessories	Mounting adapter plate incl. emergency stop switch	VZDNOTA-M	
Turnstile accessories	Control unit, electromechanical	VZDSTE	15.00
Turnstile accessories	Control unit, mechanical	VZDSTM	15.00
Turnstile accessories	Ball bearing	VZDKUG	0.09
Turnstile accessories	Turnstile floor anchoring (milled part)	VZDFRB	1.87
Turnstile accessories	Gas pressure damper for small bonnet	VZRGDK	0.25

# Compact by design. Built for security. When flexibility becomes strength.

The **V-Turnstile-Compact-Steelplate** delivers efficient access control in a compact, mobile design. Manufactured from galvanized steel and mounted on a robust steel plate, it combines stability and flexibility – ideal for temporary use on construction sites, at events, or in secured areas.

The electromechanical turnstile ensures controlled pedestrian flow, clear access structures and a high level of security. Thanks to its well-thought-out design, it is easy to position, quick to deploy and blends seamlessly into any environment. Its lower overall height makes it ideally suited for installation inside a container.

A solution that demonstrates that security can be not only functional but also aesthetically refined – mobile, reliable and versatile.

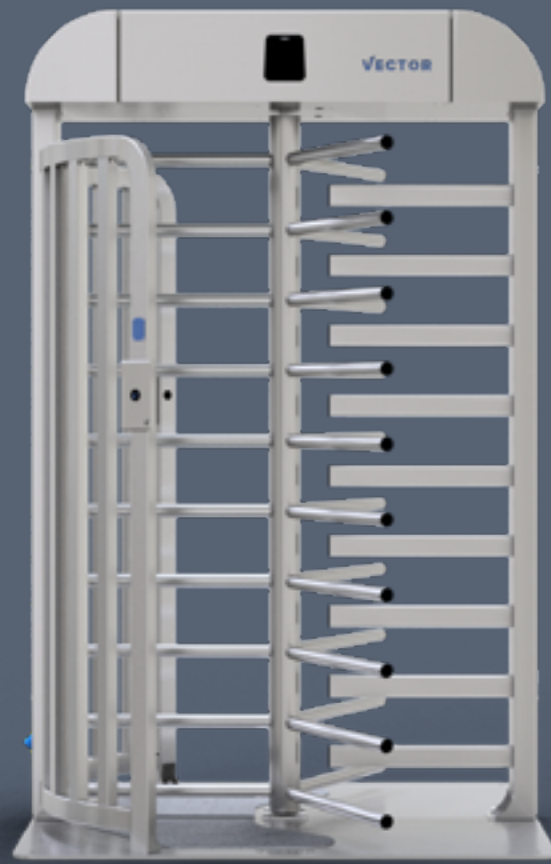

### Outstanding features: Discover the highlights of the V-Turnstile-Compact-Steelplate:

- ✓ Dimensions: 1.20 x 1.43 x 2.37 m
- ✓ Weight: 265 kg
- ✓ passage width: 0.6 m
- ✓ Profile cylinder for mechanical opening/closing
- ✓ Robust and durable bearings + shafts
- ✓ Suitable for outdoor use
- ✓ Lockable service flap
- ✓ Adjustable damping on the control unit
- ✓ Connection via 230 V CEE plug
- ✓ 24 V (electro)-mechanical control unit
- ✓ Adjustable relay hold times
- ✓ Standard fail-open, fail-close module
- ✓ Connection of various access controls if electromechanical control unit is installed
- ✓ Incl. double wire mesh fence module or construction fence module
- ✓ Customised powder coating

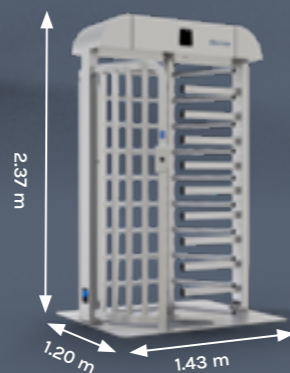

Product group	Item description	Part-No.	kg
Turnstile Compact	V-Turnstile-Compact-Steelplate-Basic	VPDKSB	387.00
Turnstile Compact	V-Turnstile-Compact-Steelplate	VPDKS	387.00

We also provide complete guard workstations, including computers, card printers and all necessary accessories



The robust shaft-hub connections and ball bearings ensure an almost maintenance-free product

Accessories	Item description	Part-No.	kg
Medium surface finish	RAL colour of choice - size M	VRALW-M	
Fence connection	2x site fence module	VZPBZ	8.00
Fence connection	Assembly 2x site fence module	VZPBZ-M	
Fence connection	2x double wire mesh fence module	VZPDZ	14.00
Fence connection	Assembly 2x double picket fence module	VZPDZ-M	
Access control	one-sided local reader	VZZZKE	0.47
Access control	Mounting one-sided local reader	VZZZKE-M	
Access control	RFID chip for local RFID access control	VZZCHIPL	0.01
Access control	Access control with 2 readers	VB-ZUKO2	5.00
Access control	Mounting access control with 2 readers	VB-ZUKO2-M	
Access control	Wiring customer access system	VZIWIRE	
Turnstile accessories	LED with pictogram on both sides	VZDLED	0.80
Turnstile accessories	Mounting double-sided LED with pictogram	VZDLED-M	
Turnstile accessories	LED Components	VZELED	0.80
Turnstile accessories	Installation LED Components	VZELED-M	
Turnstile accessories	Adapter plate incl. emergency stop switch	VZDNOTA	0.06
Turnstile accessories	Mounting adapter plate incl. emergency stop switch	VZDNOTA-M	
Turnstile accessories	Control unit, electromechanical	VZDSTE	15.00
Turnstile accessories	Control unit, mechanical	VZDSTM	15.00
Turnstile accessories	Ball bearing	VZDKUG	0.09
Turnstile accessories	Turnstile floor anchoring (milled part)	VZDFRB	1.87
Turnstile accessories	Gas pressure damper for small bonnet	VZRGDK	0.25

# Security with a solid foundation: The V-Turnstile-Compact-Fix ensures secure access with permanent stability.

When long-term security is required, the **V-Turnstile-Compact-Fix** provides the ideal solution. This permanently mounted turnstile ensures orderly processes and controlled access – wherever flexibility gives way to a solid, permanent installation.

Its robust galvanized steel construction stands for durability and reliability. Whether on construction sites, in industrial facilities, or at event venues, the system impresses with clear structure, ease of use and consistent security.

An access solution that makes stability visible – firmly anchored, secure, and aesthetically refined at the same time.

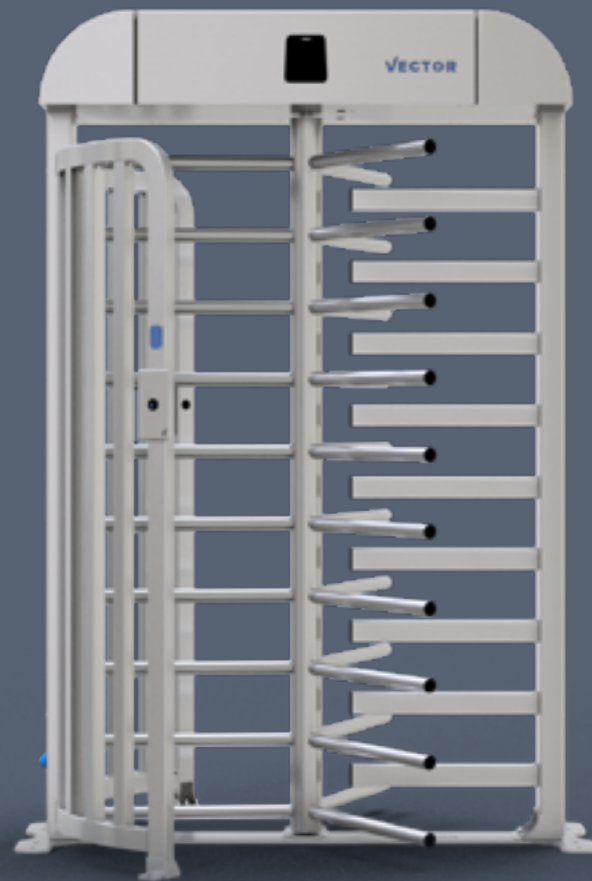

### Outstanding features: Discover the highlights of the V-Turnstile-Compact-Fix:

- ✓ Dimensions: 1.20 x 1.43 x 2.27 m
- ✓ Weight: 273 kg
- ✓ Passage width: 0,6 m
- ✓ On steel plate for doweling
- ✓ Suitable for outdoor use
- ✓ Connection via 230 V CEE plug
- ✓ 24 V (electro)mechanical control unit
- ✓ Electromechanical control unit
- ✓ Profile cylinder for mechanical opening/closing
- ✓ Robust and durable bearings + shafts
- ✓ Lockable service flap
- ✓ Adjustable damping on the control unit
- ✓ Access control can be connected on both sides
- ✓ Flexible fence connection
- ✓ Custom powder coating

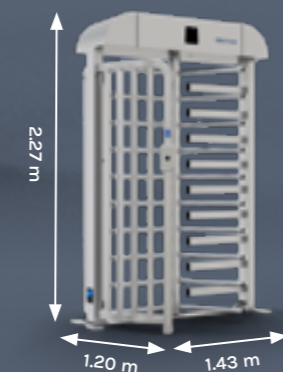

Product group	Item description	Part-No.	kg
Turnstile Compact	V-Turnstile-Compact-Fix-Basic	VDPKFB	273.00
Turnstile Compact	V-Turnstile-Compact-Fix	VDPKF	273.00



Accessories	Item description	Part-No.	kg
Medium surface finish	RAL colour of choice - size M	VRALW-M	
Fence connection	2x site fence module	VZPBZ	8.00
Fence connection	Assembly 2x site fence module	VZPBZ-M	
Fence connection	2x double wire mesh fence module	VZPDZ	14.00
Fence connection	Assembly 2x double picket fence module	VZPDZ-M	
Access control	one-sided local reader	VZZZKE	0.47
Access control	Mounting one-sided local reader	VZZZKE-M	
Access control	RFID chip for local RFID access control	VZZCHIPL	0.01
Access control	Access control with 2 readers	VB-ZUKO2	5.00
Access control	Mounting access control with 2 readers	VB-ZUKO2-M	
Access control	Wiring customer access system	VZIWIRE	
Turnstile accessories	LED with pictogram on both sides	VZDLED	0.80
Turnstile accessories	Mounting double-sided LED with pictogram	VZDLED-M	
Turnstile accessories	LED Components	VZELED	0.80
Turnstile accessories	Installation LED Components	VZELED-M	
Turnstile accessories	Adapter plate incl. emergency stop switch	VZDNOTA	0.06
Turnstile accessories	Mounting adapter plate incl. emergency stop switch	VZDNOTA-M	
Turnstile accessories	Control unit, electromechanical	VZDSTE	15.00
Turnstile accessories	Control unit, mechanical	VZDSTM	15.00
Turnstile accessories	Ball bearing	VZDKUG	0.09
Turnstile accessories	Turnstile floor anchoring (milled part)	VZDFRB	1.87
Turnstile accessories	Gas pressure damper for small bonnet	VZRGDK	0.25

# Security across the board.

## The V-Turnstile-Compact-Guard ensures controlled access with maximum protection.

When access control needs to be more than just a passage, the **V-Turnstile-Compact-Guard** provides the right solution. As a compact turnstile tunnel, it combines robust construction with well-thought-out design, creating a secure passage for particularly sensitive areas.

The solid galvanized steel structure mounted on a mobile concrete platform stands for durability, stability and protection. Whether on construction sites, at events, or in security-critical zones, the system ensures orderly processes, controlled pedestrian flow and clearly defined access points.

An access solution that makes security tangible – functional, mobile and reliable in every situation.

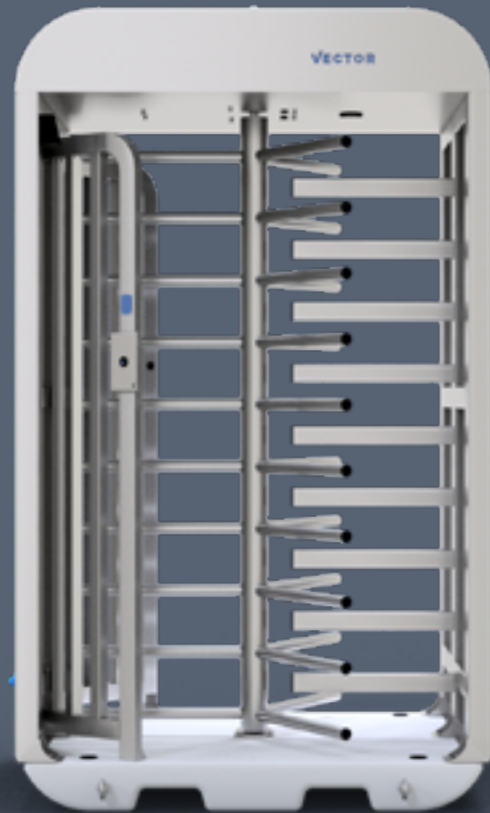

### Outstanding features: Discover the highlights of the V-Turnstile-Compact-Guard:

- ✓ Dimensions: 1.20 x 1.43 x 2.42 m
- ✓ Weight: 999 kg
- ✓ Passage width: 0.6 m
- ✓ On mobile concrete platform with adjustable feet
- ✓ Suitable for outdoor use
- ✓ Electromechanical control unit
- ✓ Connection via 230 V CEE plug
- ✓ 24 V (electro)mechanical control unit
- ✓ Adjustable relay holding times
- ✓ Profile cylinder for mechanical opening/closing
- ✓ Robust and durable bearings + shafts
- ✓ Lockable service flap
- ✓ Adjustable damping on the control unit
- ✓ Fail-open, fail-close module
- ✓ Access control can be connected on both sides
- ✓ Flexible fence connection
- ✓ Individual powder coating

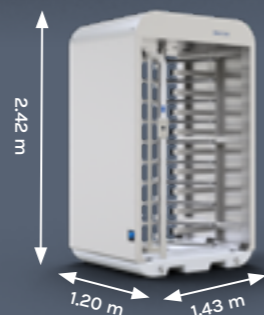

Product group	Item description	Part-No.	kg
Turnstile Compact Guard	V-Turnstile-Compact-Guard-Basic	VPDKTB	999.00
Turnstile Compact Guard	V-Turnstile-Compact-Guard	VPDKT	999.00



Thanks to the profile cylinders integrated beneath the turnstile canopy, the locking directions can be individually adjusted. For example, the exit direction can be configured to allow passage without access control

The motion-activated LED lighting ensures good visibility even at night

The Guard versions also feature an integrated service hatch that makes maintenance work easy for authorized personnel

Accessories	Item description	Part-No.	kg
Large surface finish	RAL colour of choice - size L	VRALW-L	
Fence connection	2x site fence module	VZPBZ	8.00
Fence connection	Assembly 2x site fence module	VZPBZ-M	
Fence connection	2x double wire mesh fence module	VZPDZ	14.00
Fence connection	Assembly 2x double picket fence module	VZPDZ-M	
Access control	one-sided local reader	VZZZKE	0.47
Access control	Mounting one-sided local reader	VZZZKE-M	
Access control	RFID chip for local RFID access control	VZZCHIPL	0.01
Access control	Access control with 2 readers	VB-ZUKO2	5.00
Access control	Mounting access control with 2 readers	VB-ZUKO2-M	
Access control	Wiring customer access system	VZIWIRE	
Turnstile accessories	LED with pictogram on both sides	VZDLED	0.80
Turnstile accessories	Mounting double-sided LED with pictogram	VZDLED-M	
Turnstile accessories	Adapter plate incl. emergency stop switch	VZDNOTA	0.06
Turnstile accessories	Mounting adapter plate incl. emergency stop switch	VZDNOTA-M	
Turnstile accessories	Control unit, electromechanical	VZDSTE	15.00
Turnstile accessories	Control unit, mechanical	VZDSTM	15.00
Turnstile accessories	Ball bearing	VZDKUG	0.09
Turnstile accessories	Turnstile floor anchoring (milled part)	VZDFRB	1.87
Turnstile accessories	Gas pressure damper for small bonnet	VZRGDK	0.25

# Access with foresight: The V-Turnstile-Bike-Steelplate – designed for both people and bicycles alike.

Whether at industrial sites, construction areas, or event venues – the **V-Turnstile-Bike-Steelplate** ensures regulated access while providing dedicated space for bicycles. The electromechanical turnstile with integrated bicycle passage combines convenience and security in one system, enabling controlled entry for both pedestrians and cyclists.

Manufactured from galvanized steel and mounted on a mobile steel plate, this access solution stands out with its robust design, flexible applications and modern appearance. Ideal wherever sustainable mobility and structured access control come together – stable, well-designed and ready for mobile use.



### Outstanding features: Discover the highlights of the V-Turnstile-Bike-Steelplate:

- ✓ Dimensions: 1.20 x 2.42 x 2.18 m
- ✓ Weight: 542 kg
- ✓ Passage width: 0.6 m
- ✓ Drive-through width: 0.65 m
- ✓ On mobile steel plate
- ✓ Suitable for outdoor use
- ✓ Connection via 230 V CEE plug
- ✓ 24 V (electro)mechanical control unit
- ✓ Adjustable relay holding times
- ✓ Profile cylinder for mechanical opening/closing
- ✓ Robust and durable bearings + shafts
- ✓ Lockable service flap
- ✓ Adjustable damping on the control unit
- ✓ Fail-open, fail-close module
- ✓ Motorised bicycle door with magnetic lock for locking
- ✓ 2x reader plates per side, for individual control of access points
- ✓ Access control can be connected on both sides
- ✓ Flexible fence connection
- ✓ Individual powder coating

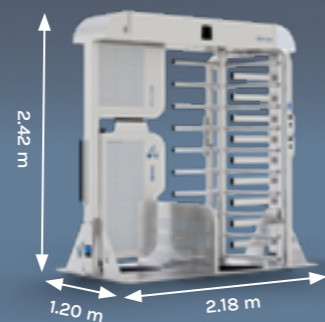

Product group	Item description	Part-No.	kg
Turnstile Bike	V-Turnstile-Bike-Steelplate	VPDFS	542.00

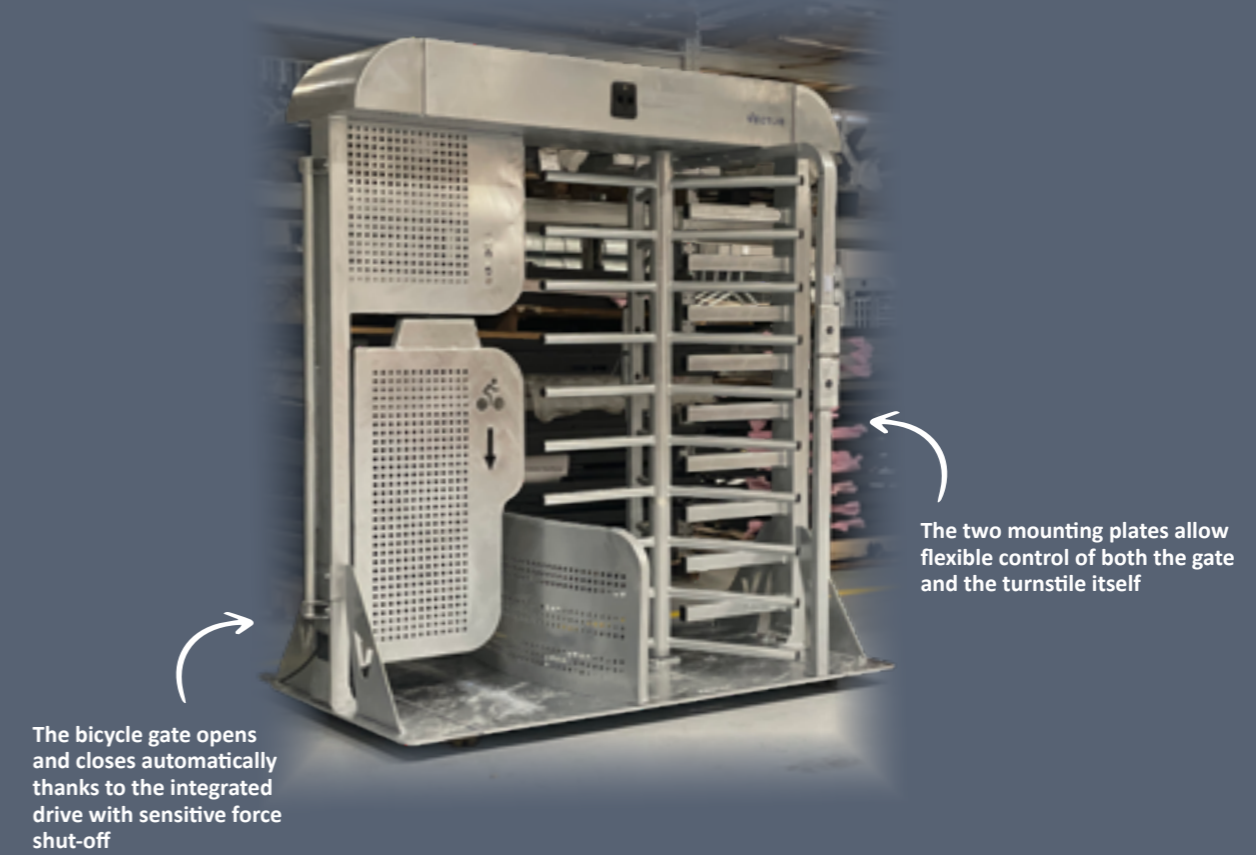

Accessories	Item description	Part-No.	kg
Large surface finish	RAL colour of choice - size L	VRALW-L	
Fence connection	2x site fence module	VZPBZ	8.00
Fence connection	Assembly 2x site fence module	VZPBZ-M	
Fence connection	2x double wire mesh fence module	VZPDZ	14.00
Fence connection	Assembly 2x double picket fence module	VZPDZ-M	
Access control	one-sided local reader	VZZZKE	0.47
Access control	Mounting one-sided local reader	VZZZKE-M	
Access control	RFID chip for local RFID access control	VZZCHIPL	0.01
Access control	Access control with 2 readers	VB-ZUKO2	5.00
Access control	Mounting access control with 2 readers	VB-ZUKO2-M	
Access control	Wiring customer access system	VZIWIRE	
Turnstile accessories	LED with pictogram on both sides	VZDLED	0.80
Turnstile accessories	Mounting double-sided LED with pictogram	VZDLED-M	
Turnstile accessories	Adapter plate incl. emergency stop switch	VZDNOTA	0.06
Turnstile accessories	Mounting adapter plate incl. emergency stop switch	VZDNOTA-M	
Turnstile accessories	Control unit, electromechanical	VZDSTE	15.00
Turnstile accessories	Control unit, mechanical	VZDSTM	15.00
Turnstile accessories	Ball bearing	VZDKUG	0.09
Turnstile accessories	Turnstile floor anchoring (milled part)	VZDFRB	1.87
Turnstile accessories	Gas pressure damper for small bonnet	VZRGDK	0.25

# V-Turnstile-Duo-Steelplate

## Twice as effective – compact, mobile, and designed for maximum pedestrian flow.

The **V-Turnstile-Duo-Steelplate** is an electromechanical double turnstile made of galvanized steel, ideal for high pedestrian volumes on construction sites, at events and in temporary installations. Thanks to its mobile steel plate base, the system can be positioned quickly and deployed flexibly – without the need for permanent installation.

With two passage widths of 0.6 m each, the turnstile ensures controlled and efficient pedestrian flow. The electromechanical control unit enables precise operation with adjustable relay times and damping. High-quality bearings, a profile cylinder and a lockable service hatch ensure durable and secure use.

Access control systems can be connected on both sides and thanks to flexible fence integration, the system can be seamlessly incorporated into existing security lines. For a customized appearance, individual powder coating is also available.

Product group	Item description	Part-No.	kg
Turnstile Duo	V-Turnstile-Duo-Steelplate	VPDDS	691.00

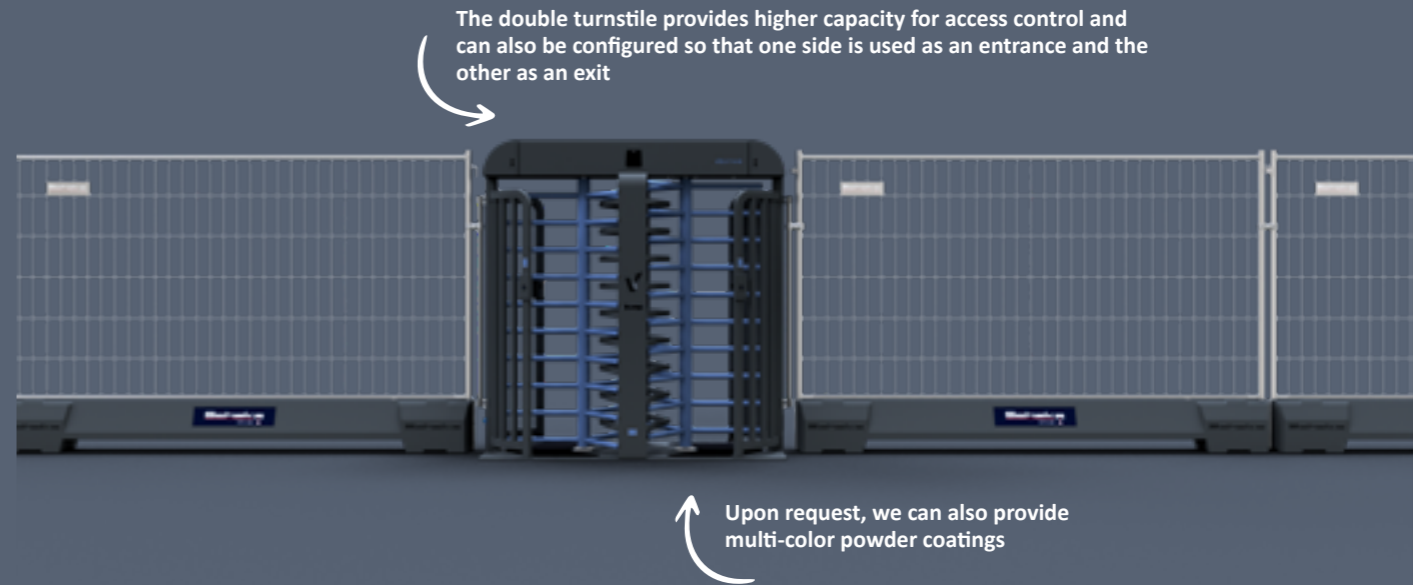

### Outstanding features: Discover the highlights of the V-Turnstile-Duo-Steelplate:

- ✓ Dimensions: 1.20 x 2.18 x 2.42 m
- ✓ Weight: 691 kg
- ✓ Passage width: 0.6 m
- ✓ On mobile steel plate
- ✓ Suitable for outdoor use
- ✓ Electromechanical control unit
- ✓ Connection via 230 V CEE plug
- ✓ 24 V (electro)mechanical control unit
- ✓ Adjustable relay holding times
- ✓ Profile cylinder for mechanical opening/closing
- ✓ Robust and durable bearings + shafts
- ✓ Lockable service flap
- ✓ Adjustable damping on the control unit
- ✓ Fail-open, fail-close module
- ✓ Access control can be connected on both sides
- ✓ Flexible fence connection
- ✓ Individual powder coating

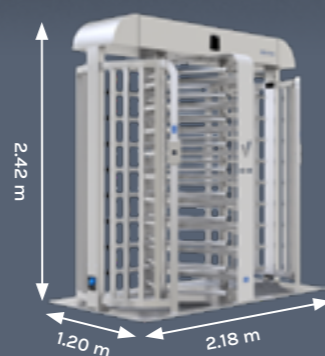

Accessories	Item description	Part-No.	kg
Large surface finish	RAL colour of choice - size L	VRALW-L	
Fence connection	2x site fence module	VZPBZ	8.00
Fence connection	Assembly 2x site fence module	VZPBZ-M	
Fence connection	2x double wire mesh fence module	VZPDZ	14.00
Fence connection	Assembly 2x double picket fence module	VZPDZ-M	
Access control	one-sided local reader	VZZZKE	0.47
Access control	Mounting one-sided local reader	VZZZKE-M	
Access control	RFID chip for local RFID access control	VZZCHIPL	0.01
Access control	Zuko mit 4x Readern	VB-ZUKO4	5.50
Access control	Access control with 4 readers	VB-ZUKO4-M	
Access control	Wiring customer access systems	VZIWIRE	
Turnstile accessories	LED with pictogram on both sides	VZDLED	0.80
Turnstile accessories	Mounting double-sided LED with pictogram	VZDLED-M	
Turnstile accessories	LED Components	VZELED	0,80
Turnstile accessories	Installation LED Components	VZELED-M	
Turnstile accessories	Adapter plate incl. emergency stop switch	VZDNOTA	0.06
Turnstile accessories	Mounting adapter plate incl. emergency stop switch	VZDNOTA-M	
Turnstile accessories	Control unit, electromechanical	VZDSTE	15.00
Turnstile accessories	Control unit, mechanical	VZDSTM	15.00
Turnstile accessories	Ball bearing	VZDKUG	0.09
Turnstile accessories	Turnstile floor anchoring (milled part)	VZDFRB	1.87
Turnstile accessories	Gas pressure damper for small bonnet	VZRGDK	0.25

# Events with class: We ensure safe and stylish events.

The **V-Turnstile-Hip** is an electromechanical, waist-high turnstile made of galvanized steel – developed to ensure safe and controlled pedestrian flow on construction sites, at events, or at temporary access points. Mounted on a mobile concrete platform with leveling feet, the system can be set up quickly and repositioned with ease when required. Thanks to its robust construction, it is ideally suited for outdoor use and stands out for its durability and ease of handling.

With a passage width of 0.58 m, the **V-Turnstile-Hip** provides convenient access without compromising on security. The electromechanical control unit allows precise operation, including adjustable relay times and damping. Thanks to the fail-open/fail-close module, the system remains reliably controllable even in emergency situations.

The turnstile features a lockable service hatch, high-quality bearings and shafts and a profile cylinder for mechanical opening and closing. Access control systems can be integrated on both sides – fully tailored to your requirements.

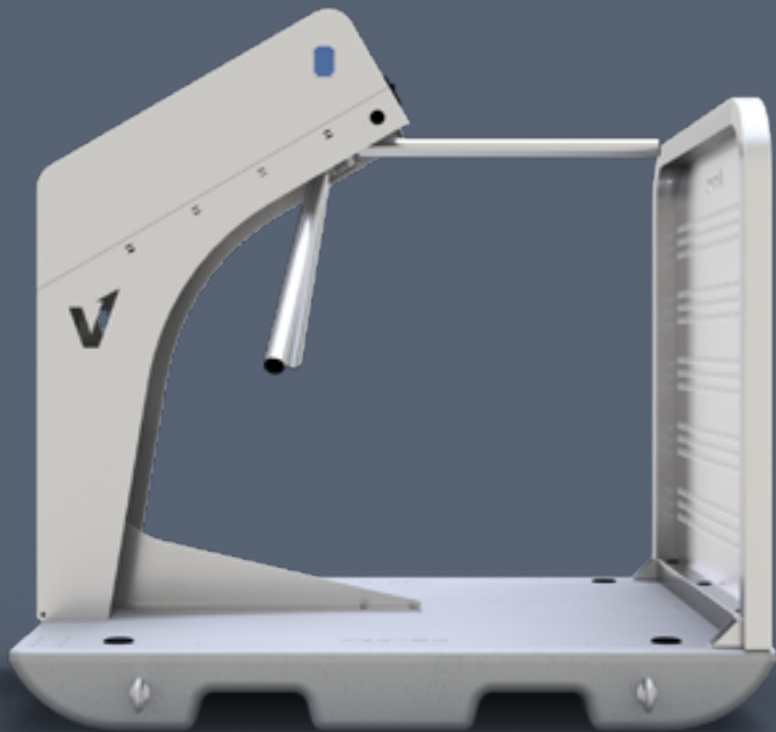

### Outstanding features: Discover the highlights of the V-Turnstile-Hip:

- ✓ Dimensions: 1.20 x 1.37 x 1.35 m
- ✓ Weight: 628 kg
- ✓ Passage width: 0,58 m
- ✓ On mobile concrete platform with adjustable feet
- ✓ Suitable for outdoor use
- ✓ Electromechanical control unit
- ✓ Connection via 230 V CEE plug
- ✓ 24 V (electro)mechanical control unit
- ✓ Adjustable relay holding times
- ✓ Profile cylinder for mechanical opening/closing
- ✓ Robust and durable bearings + shafts
- ✓ Lockable service flap
- ✓ Adjustable damping on the control unit
- ✓ Fail-open, fail-close module
- ✓ Access control can be connected on both sides
- ✓ Individual powder coating

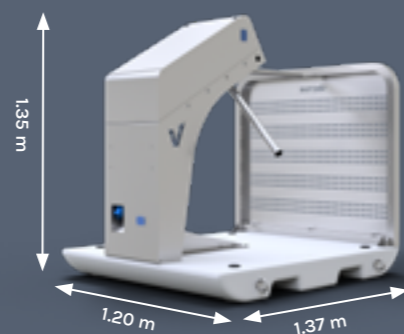

Product group	Item description	Part-No.	kg
Turnstile Hip	V-Turnstile-Hip	VPDH	628.00



In combination with crowd control barriers, the turnstiles are ideally suited for event applications

Accessories	Item description	Part-No.	kg
Large surface finish	RAL colour of choice - size L	VRALW-L	
Fence connection	2x site fence module	VZPBZ	8.00
Fence connection	Assembly 2x site fence module	VZPBZ-M	
Fence connection	2x double wire mesh fence module	VZPDZ	14.00
Fence connection	Assembly 2x double picket fence module	VZPDZ-M	
Access control	one-sided local reader	VZZZKE	0.47
Access control	Mounting one-sided local reader	VZZZKE-M	
Access control	RFID chip for local RFID access control	VZZCHIPL	0.01
Access control	Zuko mit 4x Readern	VB-ZUKO4	5.50
Access control	Access control with 4 readers	VB-ZUKO4-M	
Access control	Wiring customer access systems	VZIWIRE	
Turnstile accessories	LED with pictogram on both sides	VZDLED	0.80
Turnstile accessories	Mounting double-sided LED with pictogram	VZDLED-M	
Turnstile accessories	Adapter plate incl. emergency stop switch	VZDNOTA	0,06
Turnstile accessories	Adaptateur de montage avec arrêt d'urgence	VZDNOTA-M	
Turnstile accessories	Control unit, electromechanical	VZDSTE	15.00
Turnstile accessories	Control unit, mechanical	VZDSTM	15.00
Turnstile accessories	Ball bearing	VZDKUG	0.09
Turnstile accessories	Turnstile floor anchoring (milled part)	VZDFRB	1.87
Turnstile accessories	Gas pressure damper for small bonnet	VZRGDK	0.25

# Mobile access solutions with a system.

## Compact in transport, powerful in operation – mobile gates for maximum flexibility.

Our mobile sliding gates stand out for their efficiency, mobility and security. Their well-designed construction enables easy transport and flexible use on construction sites, at events and for temporary access solutions.

Thanks to their intelligent design, they can be set up effortlessly, controlled via remote control and repositioned as needed – whether mobile or stationary. Despite their compact design, they offer generous clear widths, robust technology, and numerous safety features such as LED warning lights, force limitation, rubber buffers and photocells.

### Proven in daily operation.



# Simple, efficient, reliable: The V-Gate-Simple simplifies the world of mobile sliding gates.

The **V-Gate-Simple** – the smart solution for straightforward access control on construction sites and at events. With its clean and simple design, this sliding gate is the ideal choice if you value user-friendliness and efficiency. Once installed, the **V-Gate-Simple** can be conveniently operated via remote control. Thanks to its versatility, it can be used both as a mobile and stationary solution and repositioned with ease.

Despite its compact size, the **V-Gate-Simple** offers a generous opening width ranging from 3.6 m up to 5.5 m, ensuring smooth traffic flow. Equipped with practical features such as a printable aluminum composite panel, a CEE plug, a rack-and-pinion drive, an LED warning light and a photocell, it meets all the requirements of modern access control.

Experience the perfect combination of simplicity, performance and reliability for your access control needs with the **V-Gate-Simple**.

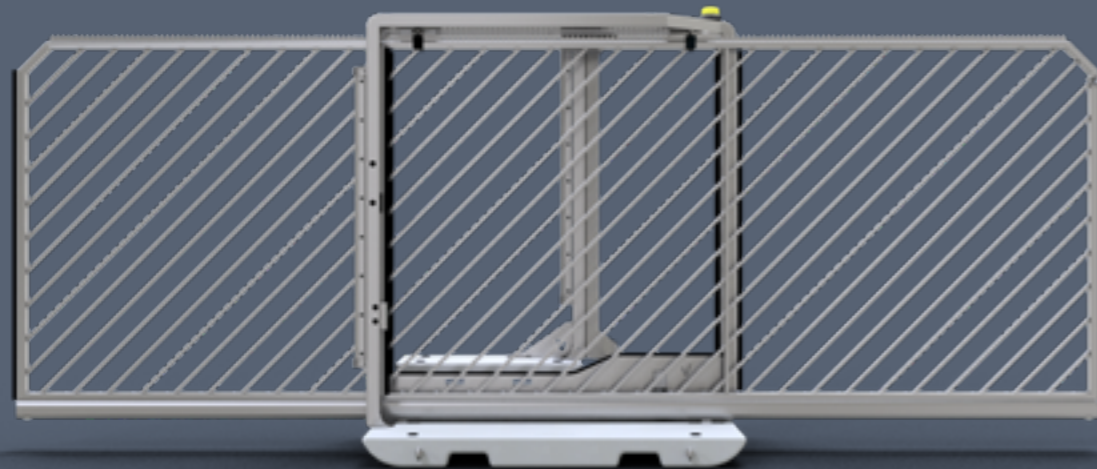

### Outstanding features: Discover the highlights of the V-Gate-Simple:

- ✓ Transport dimensions: 2.00 x 5.74 x 2.36 m (2.00 x 7.57 x 2.36 m)
- ✓ Weight: 1785 kg (1898 kg)
- ✓ Opening width: 3,6 m (5,5 m)
- ✓ On mobile concrete platform with adjustable feet
- ✓ Suitable for outdoor use
- ✓ Connection via 230 V CEE plug
- ✓ Module 4 rack and pinion drive
- ✓ Expandable control
- ✓ Light barrier
- ✓ LED rotating beacon
- ✓ Power cut-off
- ✓ Flexible folding mechanism
- ✓ Delivered with 2x hand-held transmitters
- ✓ Access control can be connected on both sides
- ✓ Flexible fence connection
- ✓ Custom powder coating

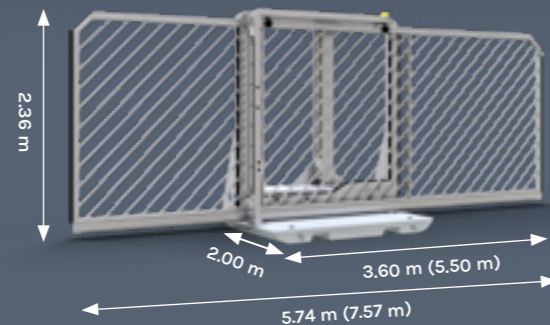

Product group	Item description	Part-No.	kg
Gate Simple	V-Gate-Simple-Basic	VPSEB	1785.00
Gate Simple	V-Gate-Simple	VPSE	1785.00
Gate Simple	V-Gate-Simple-Laser	VPSEL	1785.00
Gate Simple	V-Gate-Simple-5.5m-Basic	VPSE5B	1898.00
Gate Simple	V-Gate-Simple-5.5m	VPSE5	1898.00
Gate Simple	V-Gate-Simple-5.5m-Laser	VPSE5L	1898.00
Gate Simple	Metal sheets for V-Gate-Simple Fix variant	VZTFIX	27.00

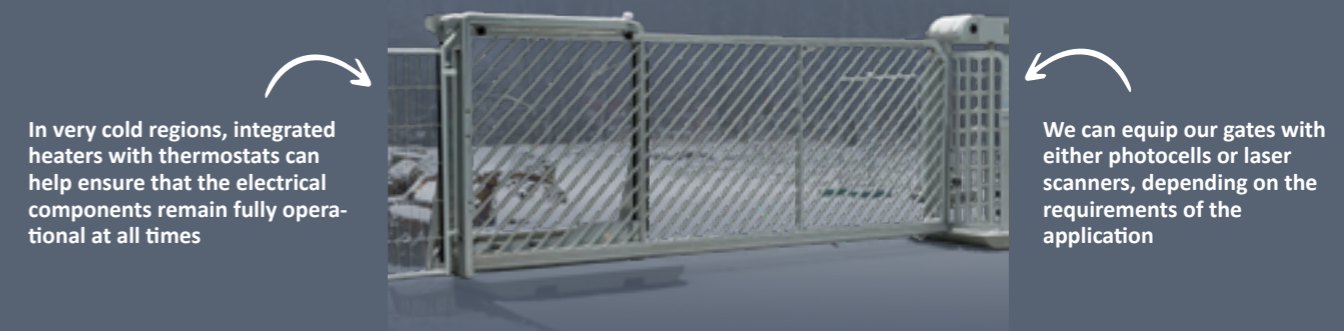

Accessories	Item description	Part-No.	kg
Very large surface finis	RAL colour of choice - size XL	VRALW-XL	
Fence connection	2x site fence module	VZPBZ	8.00
Fence connection	Assembly 2x site fence module	VZPBZ-M	
Fence connection	2x double wire mesh fence module	VZPDZ	14.00
Fence connection	Assembly 2x double picket fence module	VZPDZ-M	
Access control	one-sided local reader	VZZZKE	0.47
Access control	Mounting one-sided local reader	VZZZKE-M	
Access control	local reader on both sides	VZZZKB	0.62
Access control	Mounting local readers on both sides	VZZZKB-M	
Access control	Access control with 2 readers	VB-ZUKO2	5.00
Access control	Mounting access control with 2 readers	VB-ZUKO2-M	
Access control	Wiring customer access systems	VZIWIRE	
Gate / barrier accessories	Reflective photocell	VZTRLIS	0.20
Gate / barrier accessories	Reflector for reflective light barrier	VZSREF	0.08
Gate accessories	Light barrier	VZTLIS	0.20
Gate accessories	Motor unit pre-wired with control unit	VZTMEST	17.00
Gate accessories	Replacement motor	VZTMOT	0.50
Gate accessories	Remote control	VZTREM	0.02
Gate accessories	Radio module, incl. antenna	VZTFUNK	0.02
Gate accessories	Laserscanner incl. remote control + bracket	VZTLAS	0.40
Gate accessories	LED light	VZTLED	0.40
Gate accessories	Lashing strap	VZTZUR	0.02
Gate accessories	Guide roller, top	VZTFRO	0.89
Gate accessories	Guide roller, bottom	VZTFRU	0.81
Gate accessories	Guide roller, gate body	VZTFRT	0.04
Gate accessories	Rubber bumper, incl. aluminium strip (door body)	VZTGUMTK	4.00
Gate accessories	Rubber buffer, incl. aluminium strip (door base)	VZTGUMTB	4.00
Gate accessories	Control cabinet heater, with thermostat	VZTHZG	0.69
Gate accessories	Batterie for light barrier	VZTBAT	0.04
Gate accessories	Weekly timer	VZTZEIT	0.07
Gate accessories	Weekly time switch installation	VZTZEIT-M	
Gate accessories	Control board for the motor	VZTSTPL	0.20
Gate accessories	V-Gate inlet shoe	VZTEIN	15.00
IoT	LTE call module	VZELTE	0.20
IoT	Mounting LTE module	VZELTE-M	

# Speed meets security. The V-Fold-Steelplate – the mobile gate solution for efficient access.

When security and speed are equally important, the **V-Fold-Steelplate** stands out as a premium electric high-speed bi-fold gate solution. Manufactured from galvanized steel and mounted on a mobile steel plate, it combines stability, mobility and modern technology in one well-engineered system.

With its fast opening and closing cycles, the gate ensures smooth operations while reliably protecting sensitive areas from unauthorized access. Ideal for construction sites, logistics areas, or temporary installations – wherever efficiency, control and security need to go hand in hand.

A flexible access solution that demonstrates how function and design can form a perfect unity.

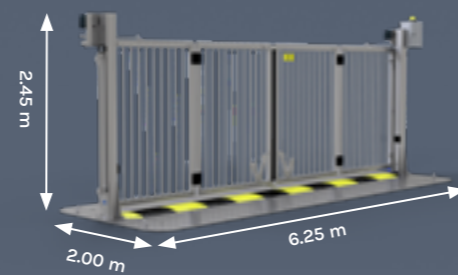
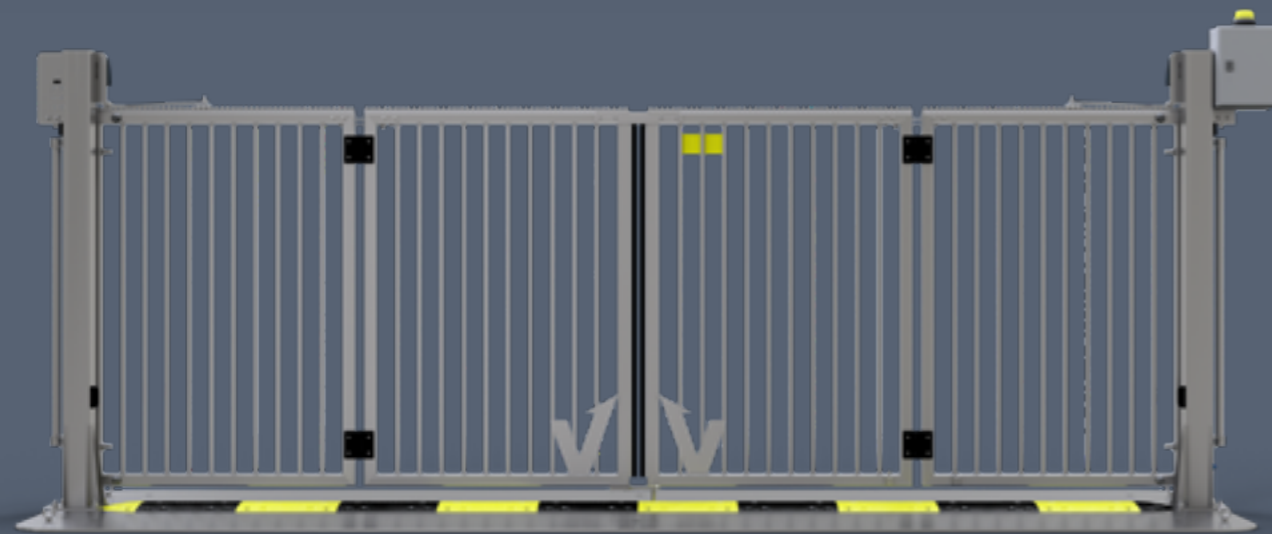

### Outstanding features: Discover the highlights of the V-Fold-Steelplate:

- ✓ Transport dimensions: 2.00 x 6.25 x 2.45 m
- ✓ Weight: 1836 kg
- ✓ Opening width: 5.50 m
- ✓ Opening/closing time ~6.5 s
- ✓ On mobile steel plate
- ✓ Suitable for outdoor use
- ✓ Connection via 230 V CEE plug
- ✓ 24 V motors for intensive use
- ✓ Expandable control system
- ✓ Light barrier
- ✓ LED rotating beacon
- ✓ Power cut-off
- ✓ Bi-folding mechanism
- ✓ Delivered with 2x hand-held transmitters
- ✓ Access control can be connected on both sides
- ✓ Flexible fence connection
- ✓ Customised powder coating

Product group	Item description	Part-No.	kg
Folding gate	V-Fold-Steelplate	VPFOS	1836.00



The steel plate is rigidly connected to the two support posts, ensuring quick installation without the need for alignment

The powerful motors can be optimized for individual applications through the external control unit by adjusting a wide range of parameters



The bi-folding mechanism ensures that the V-Fold folds quickly and in a space-saving manner

In confined spaces, the folding gate has the advantage that no additional space is required next to the opening area

Accessories	Item description	Part-No.	kg
Very large surface finish	RAL colour of choice - size XL	VRALW-XL	
Fence connection	2x site fence module	VZPBZ	8.00
Fence connection	Assembly 2x site fence module	VZPBZ-M	
Fence connection	2x double wire mesh fence module	VZPDZ	14.00
Fence connection	Assembly 2x double picket fence module	VZPDZ-M	
Folding gate accessories	LED	VZFLED	0.80
Folding gate accessories	motor	VZFMOT	11.00
Folding gate accessories	arm for motorised folding gate	VZFARM	4.50
Folding gate accessories	Control system for folding gate	VZFSTEU	6.50
Folding gate accessories	control cabinet housing	VZFSTRANK	8.50
Folding gate accessories	Bi-folding mechanism	VZFBIF	9.00
Folding gate accessories	Hinge for folding gate	VZFSTRANK	0.50
Folding gate accessories	Eye bolt for folding gate	VZFAUGEN	0.90
Folding gate accessories	Bolt for folding gate	VZFBOLZEN	0.50
Folding gate accessories	Light barrier for folding gate	VZFLIS	0.20
Folding gate accessories	Rubber buffer for folding door	VZFGUM	0.10
Folding gate accessories	Cable bridge for folding gate	VZFKAB	0.80

# Security exactly where it is needed.

**Secure, flexible and convenient** – mobile door systems for versatile access control.

Our door systems provide maximum security with minimal effort – whether mobile or permanently installed. They are ideally suited as barrier-free access points, emergency exits, or control checkpoints for a wide range of applications – from construction sites and events to permanently established facilities.

Thanks to their well-designed construction, as well as integrated forklift pockets and crane eyes, the systems can be easily positioned and deployed flexibly – both temporarily and permanently, even in confined spaces.

The doors can be combined with various access control systems and stand out with practical features such as electric strikes, door closers, industrial-grade locks, LED lighting and anti-climb protection to ensure maximum security and user convenience.

In this way, our door solutions combine functionality, efficiency and protection – wherever controlled access is required, whether temporary or permanent.

**Practical solutions for the highest standards.**

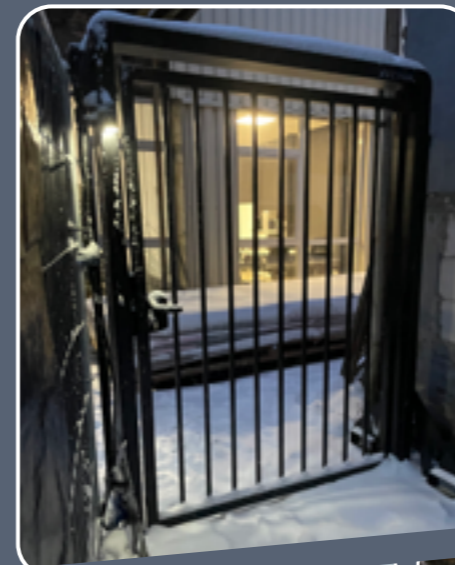

# Security at the highest level: The V-Door for every application.

**V-Door** – your ultimate solution for mobile access, whether as a barrier-free entrance or an emergency exit. Designed for versatile use on platforms, the **V-Door** offers maximum flexibility for a wide range of applications.

Thanks to integrated forklift pockets and crane eyes, the **V-Door** can be easily repositioned – whether you use it as a mobile solution or install it permanently. With dimensions of 2.00 x 1.96 x 2.35 m, it is the ideal choice for confined spaces.

A generous clear passage width of 1.79 m ensures maximum convenience for pedestrians. In addition, the **V-Door** can be equipped with various access control systems to meet your specific security requirements.

The **V-Door's** features leave nothing to be desired: a CEE plug for easy power supply, an electric strike for smooth opening and closing, an integrated door closer for enhanced safety, an industrial-grade lock for added stability and LED lighting at the front and rear along with anti-climb protection to ensure optimal visibility and security.

Experience top-level quality, flexibility and security with the **V-Door** – anytime, anywhere.

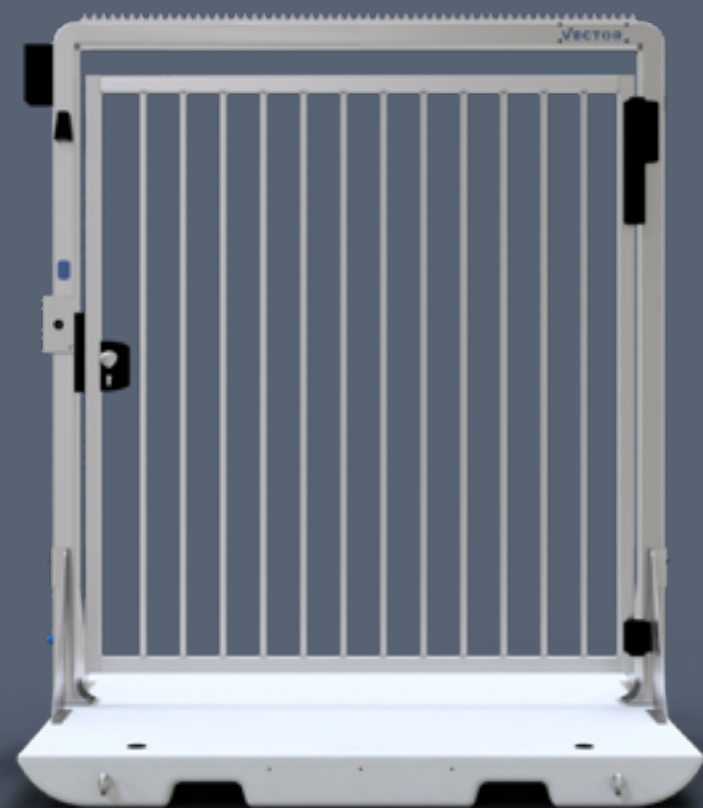

**Outstanding features: Discover the highlights of the V-Door:**

- ✓ Dimensions: 2.00 x 1.96 x 2.35 m
- ✓ Weight: 1128 kg
- ✓ Passage width: 1.79 m
- ✓ On mobile concrete platform with adjustable feet
- ✓ Suitable for outdoor use
- ✓ Door opener: electric
- ✓ Locking system: handle
- ✓ Hydraulic door closer
- ✓ Connection of access controls possible
- ✓ Flexible fence connection
- ✓ Individual powder coating

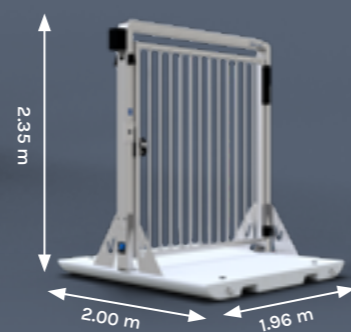

Product group	Item description	Part-No.	kg
Door	V-Door-Basic (with handle)	VPDOB	1128.00
Door	V-Door (with knob)	VPDO	1128.00
Door	V-Door-Escape-Basic (Panic function)	VPDOESB	1128.00
Door	V-Door-Escape (Panic function)	VPDOES	1128.00

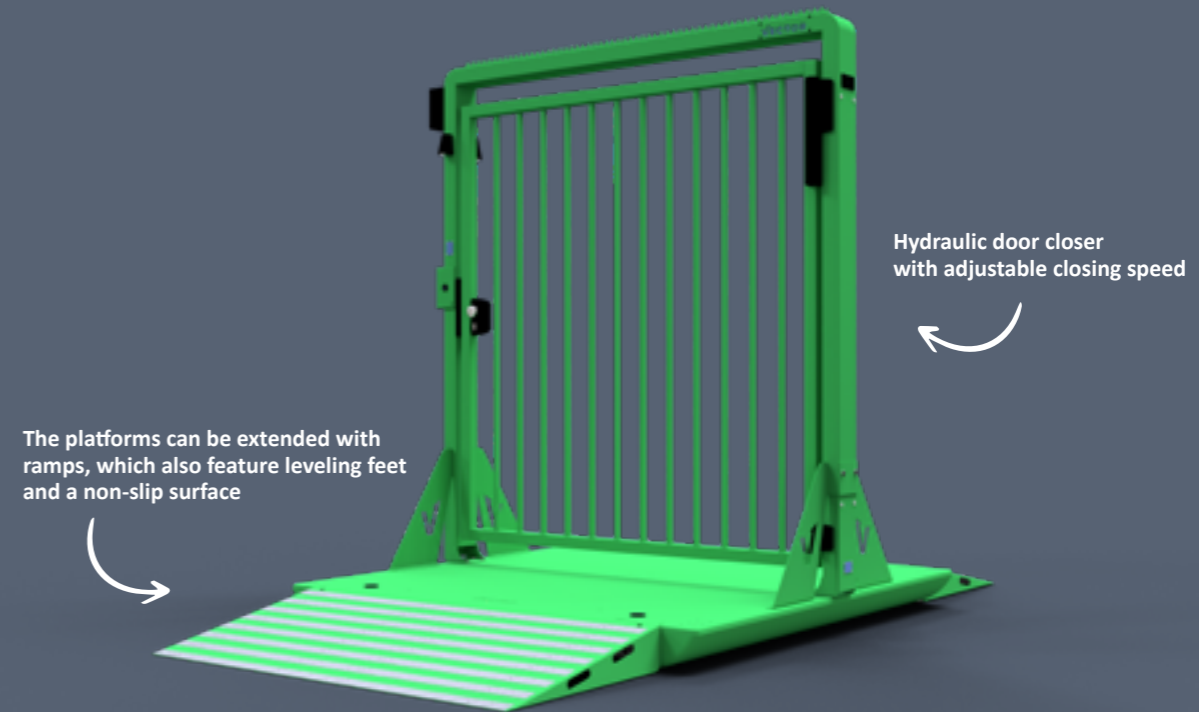

Accessories	Item description	Part-No.	kg
Medium surface finish	RAL colour of choice - size M	VRALW-M	
Fence connection	2x site fence module	VZPBZ	8.00
Fence connection	Assembly 2x site fence module	VZPBZ-M	
Fence connection	2x double wire mesh fence module	VZPDZ	14.00
Fence connection	Assembly 2x double picket fence module	VZPDZ-M	
Door accessories	Encroachment protection for site fence module	VZPBZE	23.00
Door accessories	Double rod module with intrusion protection	VZPDZE	28.00
Door accessories	Mounting external intrusion protection	VZPZE-M	
Door accessories	Internal tamper protection for V-Door	VZDOES	20.00
Door accessories	Installation of internal tamper protection	VZDOES-M	
Door accessories	Industrial lock with panic function	VZDOSP	1.30
Door accessories	Industrial lock with knob	VZDOKN	1.30
Door accessories	Industrial lock with handle	VZDOK	1.30
Door accessories	Door guard for V-Door	VZDOTW	1.50
Door accessories	Installation of door guard for V-Door	VZDOTW-M	
Access control	one-sided local reader	VZZZKE	0.47
Access control	Mounting one-sided local reader	VZZZKE-M	
Access control	RFID chip for local RFID access control	VZZCHIPL	0.01
Access control	Access control with 1 reader	VB-ZUKO1	5.00
Access control	Mounting access control with 1 reader	VB-ZUKO1-M	
Access control	Wiring customer access systems	VZIWIRE	

## Maximum security, minimal effort: Discover the V-Door-Steelplate for versatile access control.

The **V-Door-Steelplate** is a mobile door ideally suited as a barrier-free access point or emergency exit for a wide range of applications. Equipped with practical forklift pockets, it is easy to position. Its compact dimensions of 1.00 x 2.00 x 2.20 m make it an ideal choice for confined spaces.

Thanks to its versatility, the **V-Door-Steelplate** can be equipped with various access control systems and features a CEE plug, electric strike, integrated door closer, industrial-grade lock, LED lighting at the front and rear, as well as anti-climb protection for maximum security.

Discover the **V-Door-Steelplate** as the optimal solution for your access control needs – combining comfort, security, and efficiency.

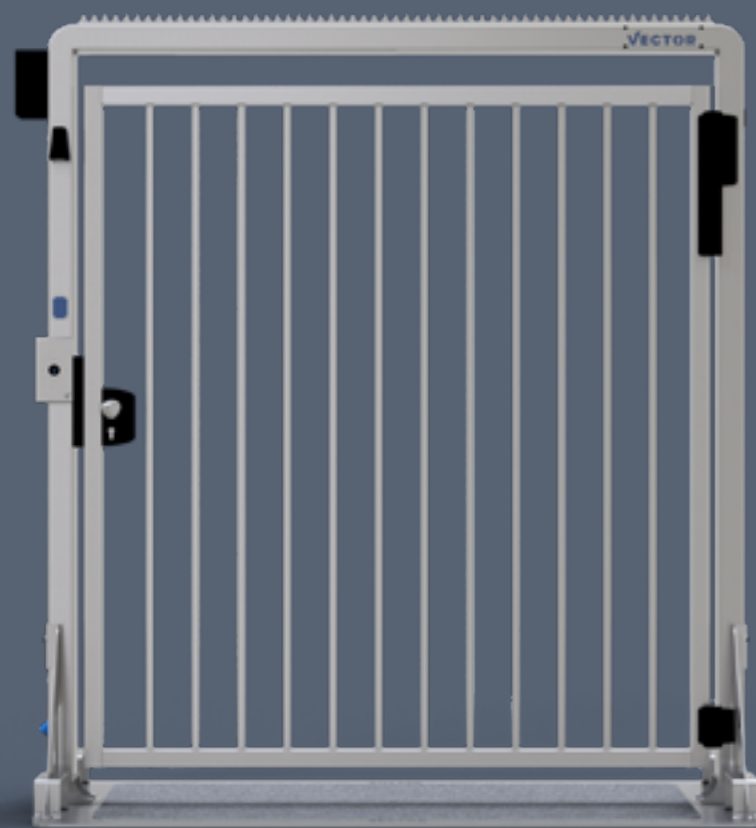

### Outstanding features: Discover the highlights of the V-Door-Steelplate:

- ✓ Dimensions: 1.00 x 2.00 x 2.20 m
- ✓ Weight: 288 kg
- ✓ Passage width: 1.79 m
- ✓ On mobile steel plate
- ✓ Suitable for outdoor use
- ✓ Door opener: electric
- ✓ Locking system: handle
- ✓ Industrial lock
- ✓ Hydraulic door closer
- ✓ Connection of access controls possible
- ✓ Flexible fence connection
- ✓ Individual powder coating

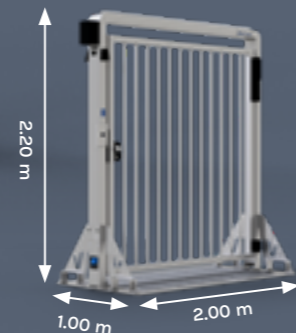

Product group	Item description	Part-No.	kg
Door	V-Door-Steelplate-Basic (with handle)	VPDOSB	288.00
Door	V-Door-Steelplate (with knob)	VPDOS	288.00
Door	V-Door-Steelplate-Escape-Basic (Panic function)	VPDOESB	288.00
Door	V-Door-Steelplate-Escape (Panic function)	VPDOSES	288.00



Our products are hot-dip galvanized, providing excellent corrosion resistance. This also applies to powder-coated products

All door and turnstile products delivered on a steel plate are equipped with grip tape

Accessories	Item description	Part-No.	kg
Medium surface finish	RAL colour of choice - size M	VRALW-M	
Fence connection	2x site fence module	VZPBZ	8.00
Fence connection	Assembly 2x site fence module	VZPBZ-M	
Fence connection	2x double wire mesh fence module	VZPDZ	14.00
Fence connection	Assembly 2x double picket fence module	VZPDZ-M	
Door accessories	Encroachment protection for site fence module	VZPBZE	23.00
Door accessories	Double rod module with intrusion protection	VZPDZE	28.00
Door accessories	Mounting external intrusion protection	VZPZE-M	
Door accessories	Internal tamper protection for V-Door	VZDOES	20.00
Door accessories	Installation of internal tamper protection	VZDOES-M	
Door accessories	Industrial lock with panic function	VZDOSP	1.30
Door accessories	Industrial lock with knob	VZDOKN	1.30
Door accessories	Industrial lock with handle	VZDOK	1.30
Door accessories	Door guard for V-Door	VZDOTW	1.50
Door accessories	Installation of door guard for V-Door	VZDOTW-M	
Access control	one-sided local reader	VZZZKE	0.47
Access control	Mounting one-sided local reader	VZZZKE-M	
Access control	RFID chip for local RFID access control	VZZCHIPL	0.01
Access control	Access control with 1 reader	VB-ZUKO1	5.00
Access control	Mounting access control with 1 reader	VB-ZUKO1-M	
Access control	Wiring customer access systems	VZIWIWE	

# Access that creates security.

## The V-Door-Fix – the compact door solution for controlled entry points.

The **V-Door-Fix** combines robust technology with functional simplicity, ensuring security wherever clearly regulated access is required.

The electric door, made of galvanized steel, is mounted on a stable steel plate and can be securely anchored to the ground – ideal for permanent or semi-permanent use on construction sites, industrial premises, or event areas.

With its compact design, the door integrates seamlessly into existing installations and provides easy, reliable access thanks to the integrated handle. Whether used in combination with access control systems, as part of escape routes, or alongside other security solutions, the **V-Door-Fix** offers a secure and durable solution for organized pedestrian flow and protected areas.

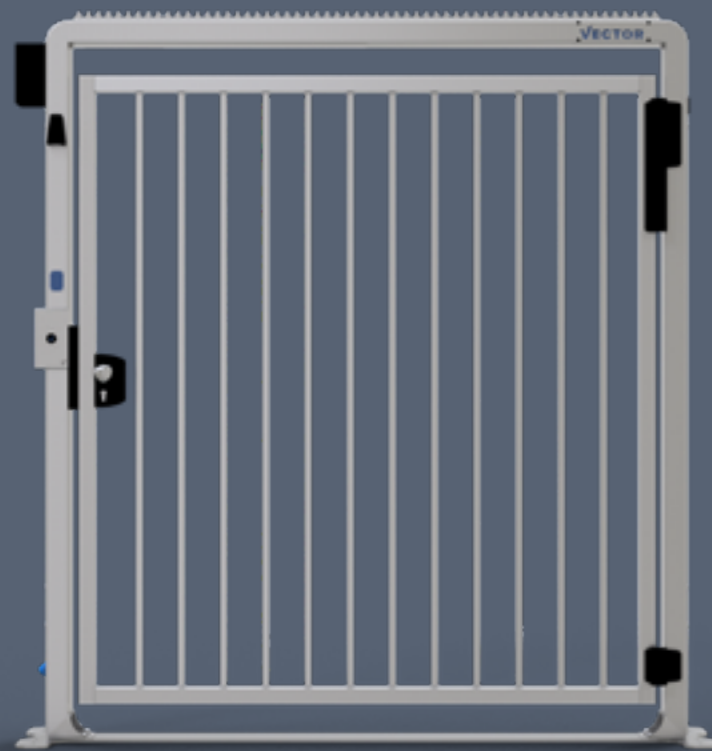

### Outstanding features: Discover the highlights of the V-Door-Fix:

- ✓ Dimensions: 0.44 x 1.96 x 2.20 m
- ✓ Weight: 147 kg
- ✓ Passage width: 1.79 m
- ✓ On steel plate for doweling
- ✓ Suitable for outdoor use
- ✓ Door opener: electric
- ✓ Locking system: handle
- ✓ Industrial lock
- ✓ Hydraulic door closer
- ✓ Connection of access controls possible
- ✓ Flexible fence connection
- ✓ Individual powder coating

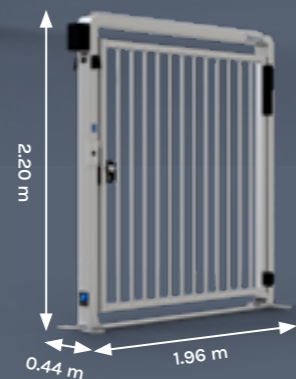

Product group	Item description	Part-No.	kg
Door	V-Door-Fix-Basic (with handle)	VPDOFB	147.00
Door	V-Door-Fix (with knob)	VPDOF	147.00
Door	V-Door-Fix-Escape-Basic (Panic function)	VPDOFESB	147.00
Door	V-Door-Fix-Escape (Panic function)	VPDOFES	147.00



Accessories	Item description	Part-No.	kg
Medium surface finish	RAL colour of choice - size M	VRALW-M	
Fence connection	2x site fence module	VZPBZ	8.00
Fence connection	Assembly 2x site fence module	VZPBZ-M	
Fence connection	2x double wire mesh fence module	VZPDZ	14.00
Fence connection	Assembly 2x double picket fence module	VZPDZ-M	
Door accessories	Encroachment protection for site fence module	VZPBZE	23.00
Door accessories	Double rod module with intrusion protection	VZPDZE	28.00
Door accessories	Mounting external intrusion protection	VZPZE-M	
Door accessories	Internal tamper protection for V-Door	VZDOES	20.00
Door accessories	Installation of internal tamper protection	VZDOES-M	
Door accessories	Industrial lock with panic function	VZDOSP	1.30
Door accessories	Industrial lock with knob	VZDOKN	1.30
Door accessories	Industrial lock with handle	VZDOK	1.30
Door accessories	Door guard for V-Door	VZDOTW	1.50
Door accessories	Installation of door guard for V-Door	VZDOTW-M	
Access control	one-sided local reader	VZZZKE	0.47
Access control	Mounting one-sided local reader	VZZZKE-M	
Access control	RFID chip for local RFID access control	VZZCHIPL	0.01
Access control	Access control with 1 reader	VB-ZUKO1	5.00
Access control	Mounting access control with 1 reader	VB-ZUKO1-M	
Access control	Wiring customer access systems	VZIWIRE	

# V-Door-Compact – access with a system.

## For secure entry points with a modern standard.

The **V-Door-Compact** is the ideal solution when functionality and mobility are equally important. As an electric door mounted on a robust concrete platform, it combines stability with flexibility – perfectly suited for temporary access points on construction sites, at events, or in secured areas.

Its compact design allows for space-saving integration into existing installations, while the galvanized steel construction and sturdy knob ensure durable and secure operation. Whether used as part of an access control system, as a service entrance, or as a flexible access unit, the **V-Door-Compact** guarantees smooth processes and controlled security in any environment.

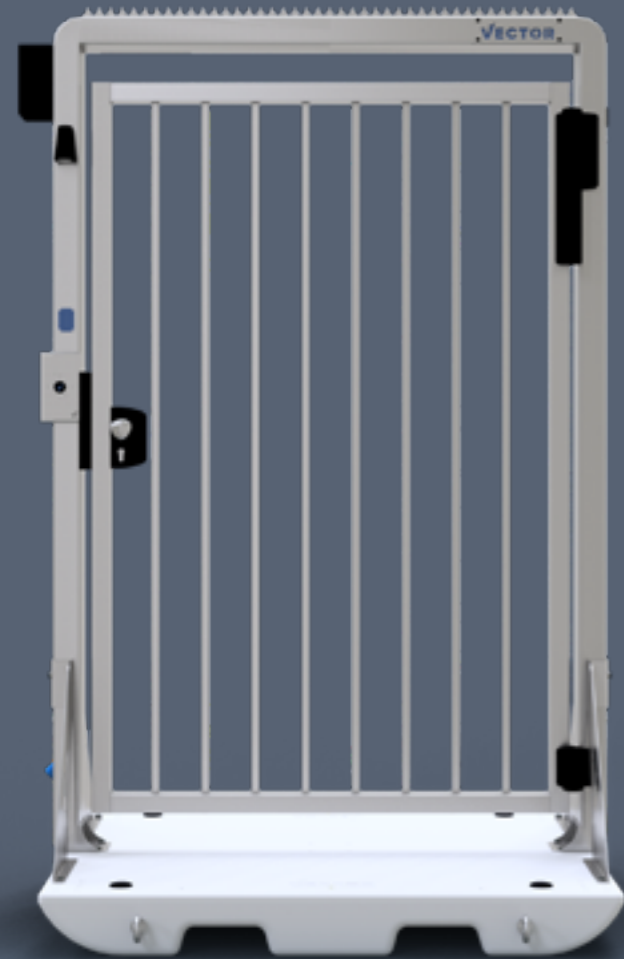

### Outstanding features: Discover the highlights of the V-Door-Compact:

- ✓ Dimensions: 1.20 x 1.46 x 2.34 m
- ✓ Weight: 625 kg
- ✓ Passage width: 1.29 m
- ✓ On mobile concrete platform with adjustable feet
- ✓ Suitable for outdoor use
- ✓ Door opener: electric
- ✓ Locking system: knob
- ✓ Hydraulic door closer
- ✓ Connection of access controls possible
- ✓ Flexible fence connection
- ✓ Individual powder coating

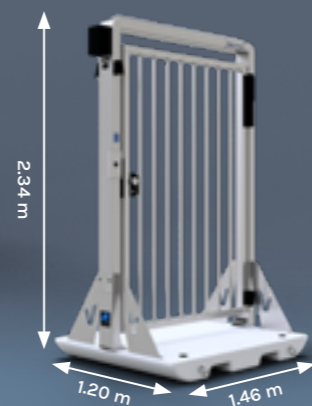

Product group	Item description	Part-No.	kg
Door Compact	V-Door-Compact-Basic (with handle)	VPDCB	625.00
Door Compact	V-Door-Compact (with knob)	VPDC	625.00
Door Compact	V-Door-Compact-Escape-Basic (Panic function)	VPDCESB	625.00
Door Compact	V-Door-Compact-Escape (Panic function)	VPDCES	625.00

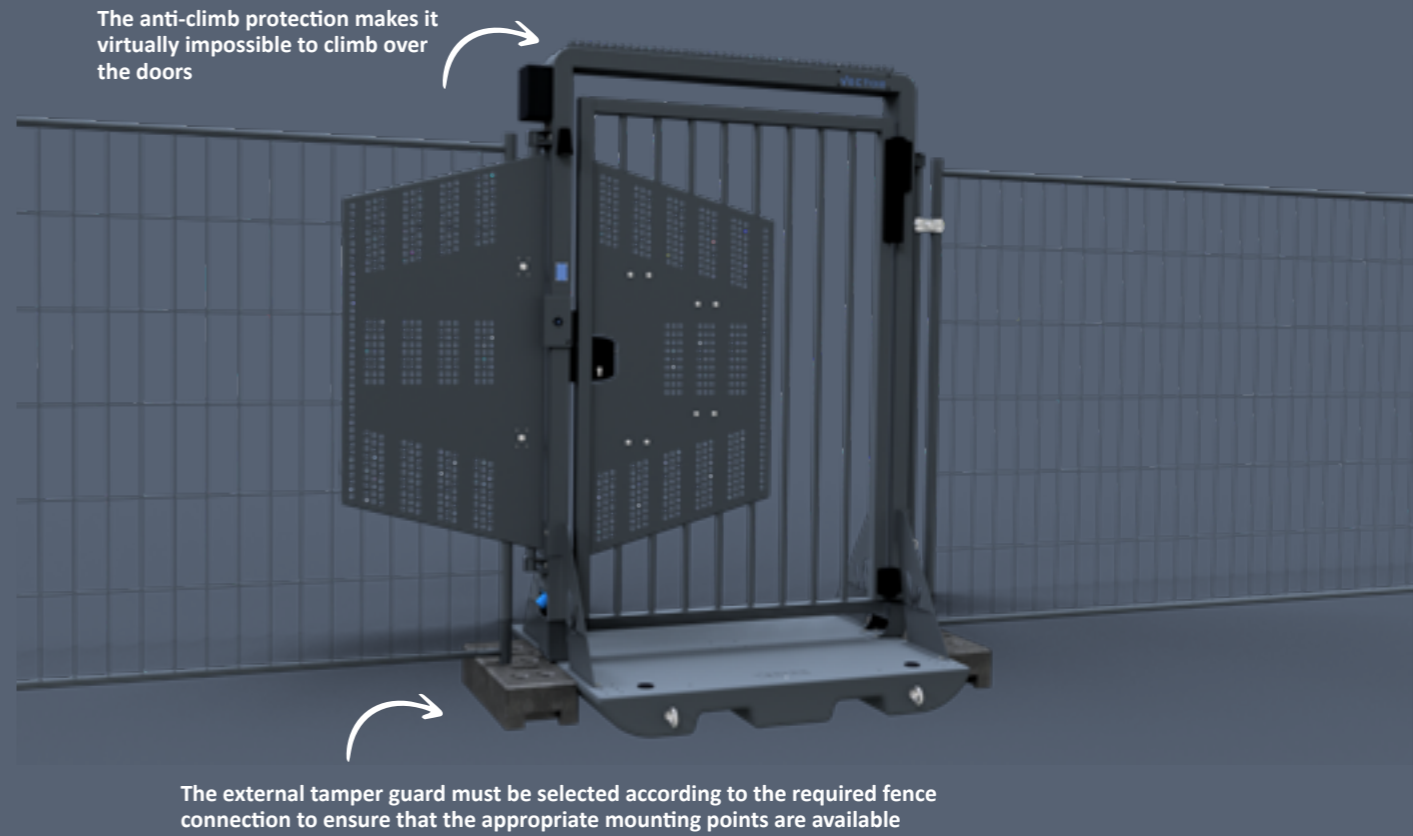

Accessories	Item description	Part-No.	kg
Medium surface finish	RAL colour of choice - size M	VRALW-M	
Fence connection	2x site fence module	VZPBZ	8.00
Fence connection	Assembly 2x site fence module	VZPBZ-M	
Fence connection	2x double wire mesh fence module	VZPDZ	14.00
Fence connection	Assembly 2x double picket fence module	VZPDZ-M	
Door accessories	Encroachment protection for site fence module	VZPBZE	23.00
Door accessories	Double rod module with intrusion protection	VZPDZE	28.00
Door accessories	Mounting external intrusion protection	VZPZE-M	
Door accessories	Internal tamper protection for V-Door	VZDOES	20.00
Door accessories	Installation of internal tamper protection	VZDOES-M	
Door accessories	Industrial lock with panic function	VZDOSP	1.30
Door accessories	Industrial lock with knob	VZDOKN	1.30
Door accessories	Industrial lock with handle	VZDOK	1.30
Door accessories	Door guard for V-Door	VZDOTW	1.50
Door accessories	Installation of door guard for V-Door	VZDOTW-M	
Access control	one-sided local reader	VZZZKE	0.47
Access control	Mounting one-sided local reader	VZZZKE-M	
Access control	RFID chip for local RFID access control	VZZCHIPL	0.01
Access control	Access control with 1 reader	VB-ZUKO1	5.00
Access control	Mounting access control with 1 reader	VB-ZUKO1-M	
Access control	Wiring customer access systems	VZIWIWE	

# Secure access – wherever it’s needed. Robust, flexible and ready for immediate use.

The **V-Door-Compact-Steelplate** is the ideal solution for construction sites, events, or temporary security areas where controlled yet convenient access is required. The door is securely mounted on a mobile steel plate, allowing for flexible deployment with minimal effort – exactly where it is needed.

Thanks to its galvanized steel body, it is optimally protected against weather conditions and perfectly suited for outdoor use. The electric door operation ensures convenient and efficient handling, while the industrial-grade lock, hydraulic door closer and robust handle provide additional security.

With its generous clear passage width of 1.29 m, the **V-Door-Compact-Steelplate** offers ample space for pedestrian traffic, material transport, or daily operations in confined areas. The door can be easily integrated into existing fencing systems and if required, combined with access control systems – making it ideal for modern security demands.

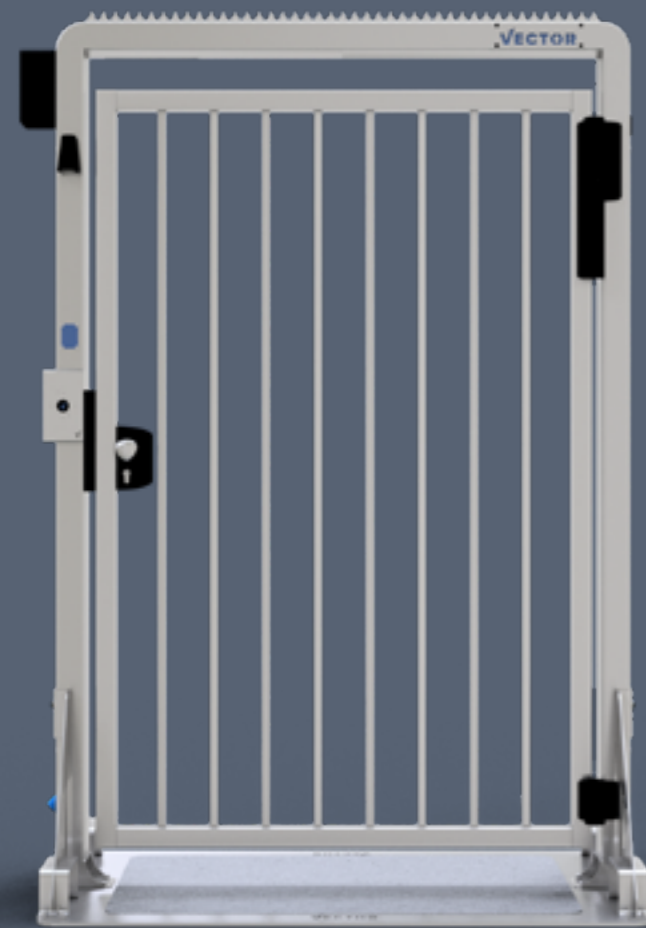

**Outstanding features: Discover the highlights of the V-Door-Compact-Steelplate:**

- ✓ Dimensions: 1.00 x 1.46 x 2.20 m
- ✓ Weight: 227 kg
- ✓ Passage width: 1.29 m
- ✓ On mobile steel plate
- ✓ Suitable for outdoor use
- ✓ Door opener: electric
- ✓ Locking system: handle
- ✓ Industrial lock
- ✓ Hydraulic door closer
- ✓ Connection of access controls possible
- ✓ Flexible fence connection
- ✓ Individual powder coating



Product group	Item description	Part-No.	kg
Door Compact	V-Door-Compact-Steelplate-Basic (with handle)	VPDCSB	227.00
Door Compact	V-Door-Compact-Steelplate (with knob)	VPDCS	227.00
Door Compact	V-Door-Compact-Steelplate-Escape-Basic (Panic function)	VPDCSESB	227.00
Door Compact	V-Door-Compact-Steelplate-Escape (Panic function)	VPDCSES	227.00



Forklift pockets are also integrated into the doors mounted on a steel plate

All products are equipped with a 230 V CEE plug, allowing for true plug-and-play operation

Accessories	Item description	Part-No.	kg
Medium surface finish	RAL colour of choice - size M	VRALW-M	
Fence connection	2x site fence module	VZPBZ	8.00
Fence connection	Assembly 2x site fence module	VZPBZ-M	
Fence connection	2x double wire mesh fence module	VZPDZ	14.00
Fence connection	Assembly 2x double picket fence module	VZPDZ-M	
Door accessories	Encroachment protection for site fence module	VZPBZE	23.00
Door accessories	Double rod module with intrusion protection	VZPDZE	28.00
Door accessories	Mounting external intrusion protection	VZPZE-M	
Door accessories	Internal tamper protection for V-Door	VZDOES	20.00
Door accessories	Installation of internal tamper protection	VZDOES-M	
Door accessories	Industrial lock with panic function	VZDOSP	1.30
Door accessories	Industrial lock with knob	VZDOKN	1.30
Door accessories	Industrial lock with handle	VZDOK	1.30
Door accessories	Door guard for V-Door	VZDOTW	1.50
Door accessories	Installation of door guard for V-Door	VZDOTW-M	
Access control	one-sided local reader	VZZZKE	0.47
Access control	Mounting one-sided local reader	VZZZKE-M	
Access control	RFID chip for local RFID access control	VZZCHIPL	0.01
Access control	Access control with 1 reader	VB-ZUKO1	5.00
Access control	Mounting access control with 1 reader	VB-ZUKO1-M	
Access control	Wiring customer access systems	VZIWIRE	

# V-Door-Compact-Fix – access with a system.

## The permanently mounted steel door for long-term outdoor security.

The **V-Door-Compact-Fix** is the ideal solution for all areas where a fixed, permanently secured access point is required. Thanks to its sturdy steel plate, the door can be anchored directly to the ground, ensuring a particularly reliable and durable installation – perfect for construction sites, industrial facilities, or secured outdoor areas.

Manufactured from galvanized steel, the door is optimally protected against weather conditions and perfectly suited for outdoor use. The electric door strike enables convenient and efficient access, while the robust industrial-grade lock, handle and hydraulic door closer ensure security and controlled closing.

With its generous clear passage width of 1.29 m, the **V-Door-Compact-Fix** provides ample space for daily pedestrian traffic and can be seamlessly integrated into existing systems thanks to its flexible fence connection.

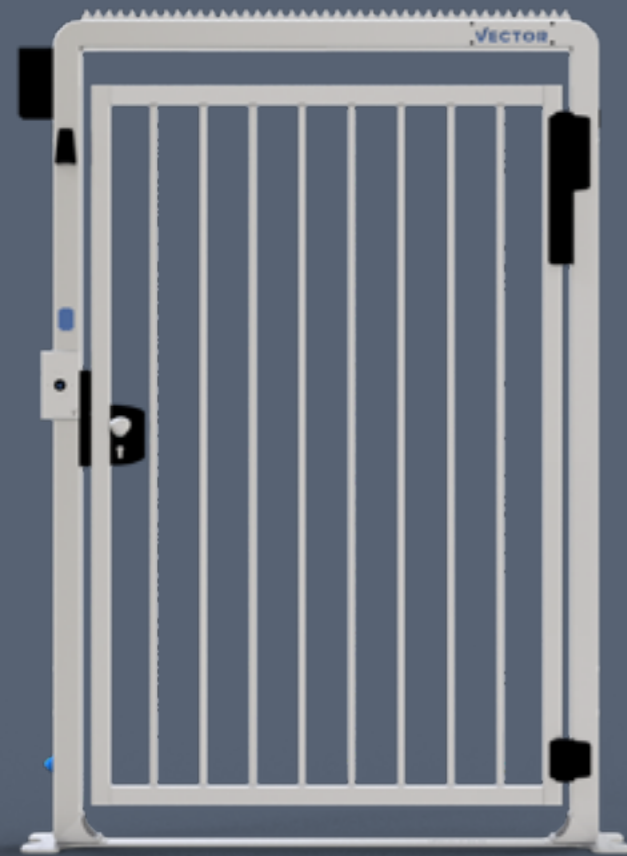

### Outstanding features: Discover the highlights of the V-Door-Compact-Fix:

- ✓ Dimensions: 0.44 x 1.46 x 2.20 m
- ✓ Weight: 121 kg
- ✓ Passage width: 1.29 m
- ✓ On steel plate for doweling
- ✓ Suitable for outdoor use
- ✓ Door opener: electric
- ✓ Locking system: handle
- ✓ Industrial lock
- ✓ Hydraulic door closer
- ✓ Connection of access controls possible
- ✓ Flexible fence connection
- ✓ Individual powder coating

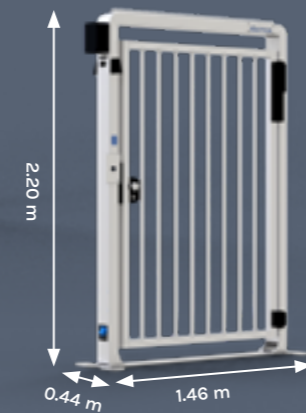

Product group	Item description	Part-No.	kg
Door Compact	V-Door-Compact-Fix-Basic (with handle)	VPDCFB	121.00
Door Compact	V-Door-Compact-Fix (with knob)	VPDCF	121.00
Door Compact	V-Door-Compact-Fix-Escape-Basic (Panic function)	VPDCFESB	121.00
Door Compact	V-Door-Compact-Fix-Escape (Panic function)	VPDCFES	121.00

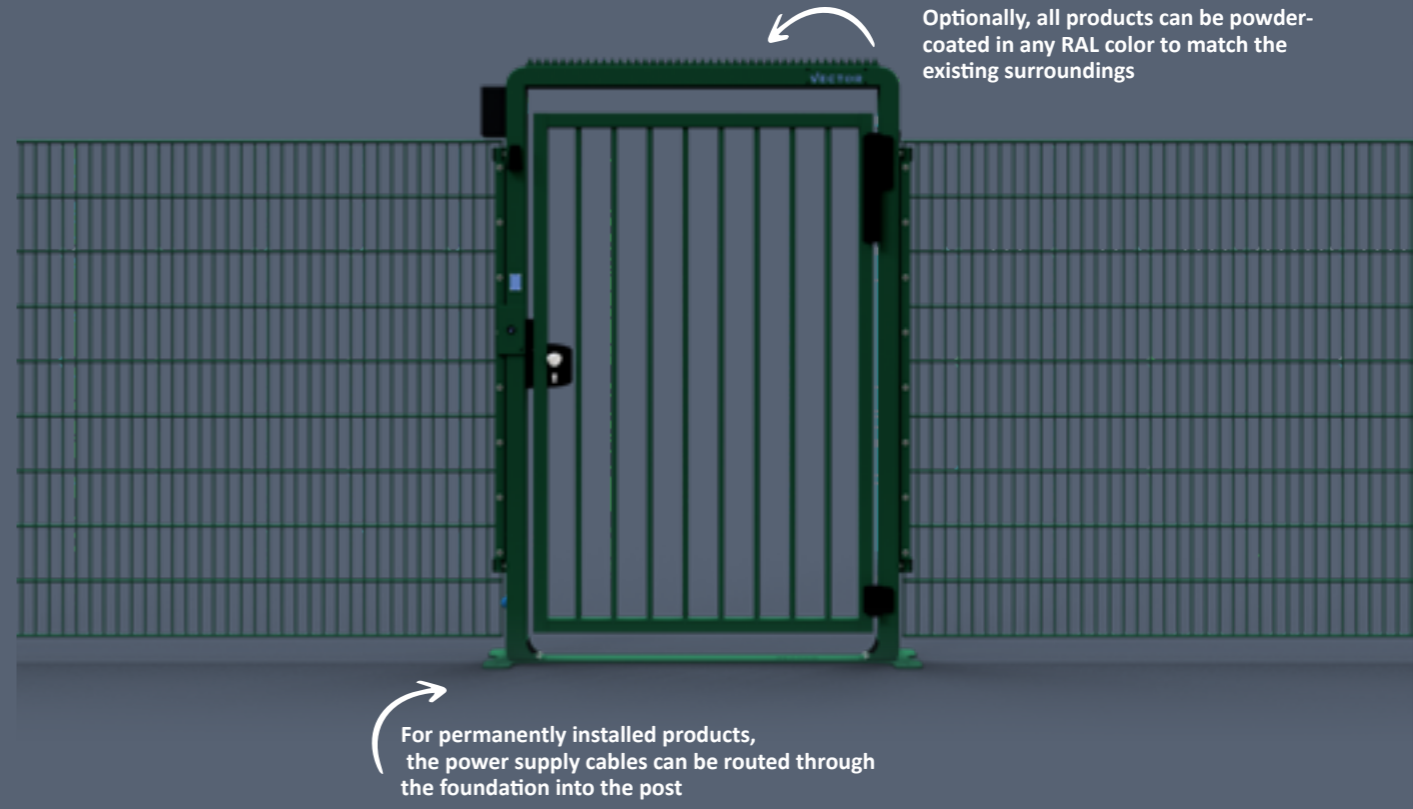

Accessories	Item description	Part-No.	kg
Medium surface finish	RAL colour of choice - size M	VRALW-M	
Fence connection	2x site fence module	VZPBZ	8.00
Fence connection	Assembly 2x site fence module	VZPBZ-M	
Fence connection	2x double wire mesh fence module	VZPDZ	14.00
Fence connection	Assembly 2x double picket fence module	VZPDZ-M	
Door accessories	Encroachment protection for site fence module	VZPBZE	23.00
Door accessories	Double rod module with intrusion protection	VZPDZE	28.00
Door accessories	Mounting external intrusion protection	VZPZE-M	
Door accessories	Internal tamper protection for V-Door	VZDOES	20.00
Door accessories	Installation of internal tamper protection	VZDOES-M	
Door accessories	Industrial lock with panic function	VZDOSP	1.30
Door accessories	Industrial lock with knob	VZDOKN	1.30
Door accessories	Industrial lock with handle	VZDOK	1.30
Door accessories	Door guard for V-Door	VZDOTW	1.50
Door accessories	Installation of door guard for V-Door	VZDOTW-M	
Access control	one-sided local reader	VZZZKE	0.47
Access control	Mounting one-sided local reader	VZZZKE-M	
Access control	RFID chip for local RFID access control	VZZCHIPL	0.01
Access control	Access control with 1 reader	VB-ZUKO1	5.00
Access control	Mounting access control with 1 reader	VB-ZUKO1-M	
Access control	Wiring customer access systems	VZIWIRE	

# Flexible systems for controlled access routes.

## Robust barriers – mobile and ready for immediate use.

Our mobile barrier solutions provide reliable vehicle access control for construction sites, events, or temporary security areas. These robust systems feature galvanized steel, electric control and a well-thought-out design that combines durability with ease of use. Whether with a boom length of 5 or 7 meters, the barriers are mounted on a stable concrete platform and are ready for operation right away. Thanks to integrated forklift pockets or crane eyes, they can be flexibly relocated and adapted to any deployment site.

The optionally available laser version ensures maximum safety in daily operation through precise sensor technology. This keeps access under control at all times – efficient, mobile and reliable.

## Reliable systems for everyday use.



# Maximum security with minimal installation effort.

The **V-Barrier-5m** is the ideal solution when access routes need to be reliably controlled and clearly defined. Whether on construction sites, industrial premises, or temporary locations, this electric barrier combines robust construction with modern access technology and is ready for immediate use.

Mounted on a mobile concrete platform, the barrier can be positioned flexibly without the need for structural groundwork. Thanks to its galvanized steel construction, it is perfectly suited for resistance to weather conditions as well as intensive daily operation.

With a clear passage width of up to 4.75 m – individually adjustable – the **V-Barrier-5m** is suitable for a wide range of access points. The 24 V drive ensures powerful and smooth operation, while the fast opening time of 3.5 to 6 seconds enables efficient traffic flow.

Numerous options such as access control systems, induction loops, traffic lights, photocells, or a pendulum support allow the barrier to be perfectly tailored to specific requirements.

For everyday use, it comes equipped with two remote controls, adjustable automatic closing and a key for manual operation – ensuring maximum flexibility.

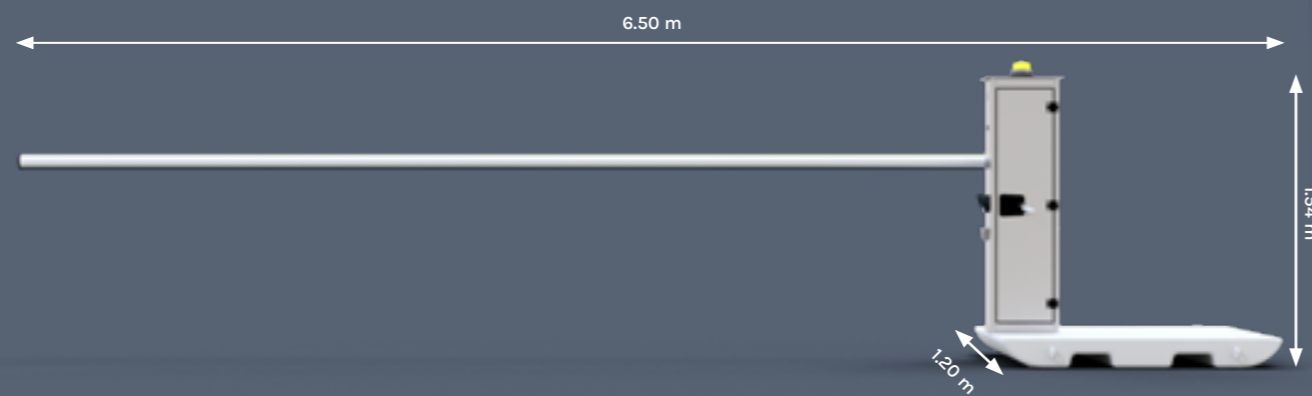

### Outstanding features: Discover the highlights of the V-Barrier-5m:

- ✓ Dimensions: 1.20 x 6.50 x 1.54 m
- ✓ Weight: 565 kg
- ✓ Passage width: 4.75 m / can be shortened to 2.75 m
- ✓ Suitable for outdoor use
- ✓ On mobile concrete platform with adjustable feet
- ✓ Connection via 230 V CEE plug
- ✓ 24 V drive
- ✓ Opening time 3.5 – 6 s
- ✓ Suitable for intensive use
- ✓ Integration of many accessories (access control, induction loop, traffic light)
- ✓ Light barrier
- ✓ Optional pendulum support and support post
- ✓ Automatic closing adjustable (standard 20 s)
- ✓ includes 2 hand-held transmitters
- ✓ Manual operation can be activated with a key
- ✓ Individual powder coating

Product group	Item description	Part-No.	kg
Barrier 5m, left	V-Barrier-5m, left-hand closing	VPBA5	565.00
Barrier 5m, left with Laser	V-Barrier-5m-Laser, left-hand closing	VPBA5L	565.00
Barrier 5m, right	V-Barrier-5m, right-hand closing	VPBA5R	565.00
Barrier 5m, right with Laser	V-Barrier-5m-Laser, right-hand closing	VPBA5RL	565.00
Support post	Support post with small platform	VZSAUF	6.50
Support post	Support posts for barriers, fixed variants	VZSAUFF	6.50



Accessories	Item description	Part-No.	kg
Small surface finish	RAL colour of choice - size S (Barrier)	VRALW-S	
Very small surface finish	RAL colour of choice - size XS (Support post)	VRALW-XS	
Access control	Access control with 1 reader	VB-ZUKO1	5.00
Access control	Mounting access control with 1 reader	VB-ZUKO1-M	
Access control	Wiring customer access systems	VZIWIRE	
Gate / barrier accessories	Retro-reflective photocell	VZTRLIS	0.20
Gate / barrier accessories	Reflector for reflective light barrier	VZSREF	0.08
Barrier accessories	Suspended grid, 2 m element	VZSHANG	4.00
Barrier accessories	Brace for the housing, when installed with a support post.	VZSHANG1	0.40
Barrier accessories	Brace for pendulum support, when no support post is used	VZSHANG2	0.11
Barrier accessories	Installation of suspended grille (per barrier)	VZSHANG-M	
Barrier accessories	Swing support	VZSPEND	15.00
Barrier accessories	Swing support for fixed variants	VZSPENDF	0.32
Barrier accessories	Mounting the pendulum support	VZSPEND-M	
Barrier accessories	Single-channel magnetic loop detector	VZSDET1	1.00
Barrier accessories	Two-channel magnetic loop detector	VZSDET2	1.00
Barrier accessories	Magnetic loop with 6 m connection cable	VZSMAG6	1.00
Barrier accessories	Magnetic loop with 10 m connection cable	VZSMAG10	1.00
Barrier accessories	Mounting magnetic loop	VZSMAG-M	
Barrier accessories	Shortenable LED for 5 m barrier boom	VZSLED5	0.10
Barrier accessories	Shortening the barrier beams	VZSKURZ	
Barrier accessories	Circuit board for synchronised operation of 2x barriers (1x circuit board required per barrier)	VZSSYN	0.01
Barrier accessories	Circuit board for synchronised operation of 2 barriers installation (Wiring of 2 barriers + testing)	VZSSYN-M	
Barrier accessories	Traffic light control	VZSAMPS	1.00
Barrier accessories	Assembly traffic light control	VZSAMPS-M	
Barrier accessories	Traffic light	VZSAMP	1.00
Barrier accessories	Installation of traffic light incl. device on barrier platform	VZSAMP-M	
Barrier accessories	Laser scanner with remote control and fixture incl. screws	VZSLAS	0.10
Barrier accessories	Handheld transmitter	VZSREM	0.01
Barrier accessories	Barrier boom 5 m	VZSSB5	
Barrier accessories	Motor + motor control unit for Barrier-5m	VZSMOT5	10.00
Barrier accessories	4-channel hand-held transmitter	VZSREM4	0.02
Barrier accessories	Laser aperture field	VZSLAS-OF	7.30
Barrier accessories	Barrier foundation plate	VZSFP	0.50
Barrier accessories	LED	VZSLED	0.80
IoT	LTE call module	VZELTE	0.20
IoT	Mounting LTE module	VZELTE-M	

# Electric barrier on a mobile concrete platform – ideal for wide access points.

The **V-Barrier-7m** is the powerful solution for extra-wide access points and demanding applications. With a maximum clear passage width of 6.7 meters, it provides ample space for large vehicles, delivery traffic, or wide construction site entrances – while remaining reliable, secure and easy to operate.

Mounted on a mobile concrete platform, the barrier can be positioned flexibly without the need for structural ground-work. Its galvanized steel housing ensures high resistance to weather conditions and intensive use – making it ideal for long-term outdoor operation.

The 24 V drive guarantees powerful and smooth opening and closing, while the fast opening time of 3.5 to 6 seconds ensures efficient traffic flow. Thanks to the option of integrating various accessories and access control systems – such as induction loops, traffic lights, or photocells – the **V-Barrier-7m** can be perfectly adapted to different security requirements.

For daily operation, it comes equipped with two remote controls, an adjustable automatic closing function and a key for manual operation.

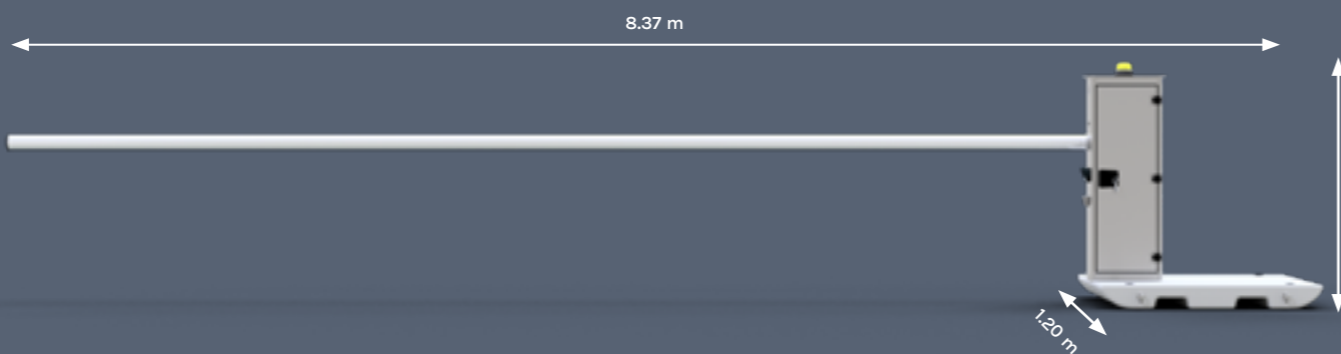

### Outstanding features: Discover the highlights of the V-Barrier-7m:

- ✓ Dimensions: 1.20 x 8.37 x 1.54 m
- ✓ Weight: 585 kg
- ✓ Passage width: 6.7 m / can be shortened to 4.7 m
- ✓ Suitable for outdoor use
- ✓ On mobile concrete platform with adjustable feet
- ✓ Connection via 230 V CEE plug
- ✓ 24 V drive
- ✓ Opening time 3.5 – 6 s
- ✓ Suitable for intensive use
- ✓ Integration of many accessories (access control, induction loop, traffic light)
- ✓ Light barrier
- ✓ Optional pendulum support and support post
- ✓ Automatic closing adjustable (standard 20 s)
- ✓ Includes 2 hand-held transmitters
- ✓ Manual operation can be activated with a key
- ✓ Individual powder coating

Product group	Item description	Part-No.	kg
Barrier 7m, left	V-Barrier-7m, left-hand closing	VPBA7	585.00
Barrier 7m, left with Laser	V-Barrier-7m-Laser, left-hand closing	VPBA7L	585.00
Barrier 7m, right	V-Barrier-7m, right-hand closing	VPBA7R	585.00
Barrier 7m, right with Laser	V-Barrier-7m-Laser, right-hand closing	VPBA7RL	585.00
Support post	Support post with small platform	VZSAUF	6.50
Support post	Support posts for barriers, fixed variants	VZSAUFF	6.50

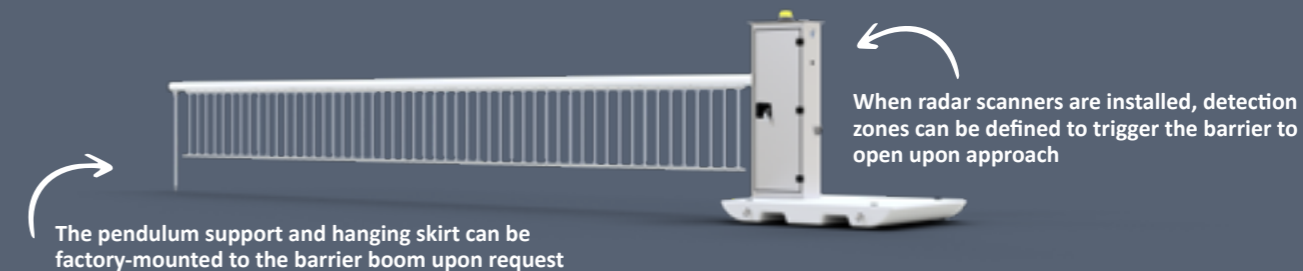

Accessories	Item description	Part-No.	kg
Small surface finish	RAL colour of choice - size S (Barrier)	VRALW-S	
Very small surface finish	RAL colour of choice - size XS (Support post)	VRALW-XS	
Access control	Access control with 1 reader	VB-ZUKO1	5.00
Access control	Mounting access control with 1 reader	VB-ZUKO1-M	
Access control	Wiring customer access systems	VZIWIRE	
Gate / barrier accessories	Retro-reflective photocell	VZTRLIS	0.20
Gate / barrier accessories	Reflector for reflective light barrier	VZSREF	0.08
Barrier accessories	Suspended grid, 2 m element	VZSHANG	4.00
Barrier accessories	Brace for the housing, when installed with a support post.	VZSHANG1	0.40
Barrier accessories	Brace for pendulum support, when no support post is used	VZSHANG2	0.11
Barrier accessories	Installation of suspended grille (per barrier)	VZSHANG-M	
Barrier accessories	Swing support	VZSPEND	15.00
Barrier accessories	Swing support for fixed variants	VZSPENDF	0.32
Barrier accessories	Mounting the pendulum support	VZSPEND-M	
Barrier accessories	Single-channel magnetic loop detector	VZSDET1	1.00
Barrier accessories	Two-channel magnetic loop detector	VZSDET2	1.00
Barrier accessories	Magnetic loop with 6 m connection cable	VZSMAG6	1.00
Barrier accessories	Magnetic loop with 10 m connection cable	VZSMAG10	1.00
Barrier accessories	Mounting magnetic loop	VZSMAG-M	
Barrier accessories	Spring for barrier-7m	VZSFED	2,00
Barrier accessories	Installation of the small spring for the barrier-7m	VZSFED-M	
Barrier accessories	Shortenable LED for 8 m barrier boom	VZSLED8	0,10
Barrier accessories	Shortening the barrier beams	VZSKURZ	
Barrier accessories	Circuit board for synchronised operation of 2x barriers (1x circuit board required per barrier)	VZSSYN	0.01
Barrier accessories	Circuit board for synchronised operation of 2 barriers installation (Wiring of 2 barriers + testing)	VZSSYN-M	
Barrier accessories	Traffic light control	VZSAMPS	1.00
Barrier accessories	Assembly traffic light control	VZSAMPS-M	
Barrier accessories	Traffic light	VZSAMP	1.00
Barrier accessories	Installation of traffic light incl. device on barrier platform	VZSAMP-M	
Barrier accessories	Laser scanner with remote control and fixture incl. screws	VZSLAS	0.10
Barrier accessories	Handheld transmitter	VZSREM	0.01
Barrier accessories	Barrier boom 7m	VZSSB7	15,3
Barrier accessories	Motor + motor control unit for Barrier-7m	VZSMOT7	10,00
Barrier accessories	4-channel hand-held transmitter	VZSREM4	0.02
Barrier accessories	Laser aperture field	VZSLAS-OF	7.30
Barrier accessories	Barrier foundation plate	VZSFP	0.50
Barrier accessories	LED	VZSLED	0.80
IoT	LTE call module	VZELTE	0.20
IoT	Mounting LTE module	VZELTE-M	

# Electric barrier mounted on a mobile concrete platform – ideal for wide access points.

The **V-Barrier-5m-Fix** is the compact solution for secure and controlled access points. Manufactured from galvanized steel, it stands out for its stability, durability and reliable electric operation – ideal for permanent outdoor use.

With its adjustable barrier width, it is perfectly suited for a wide range of applications, from construction sites and industrial premises to event areas. The smooth and fast opening movement ensures efficient traffic flow, even with frequent use.

Thanks to its fixed installation, the **V-Barrier-5m-Fix** remains stable even under high traffic volumes. At the same time, it can be expanded with various accessories as needed – such as access control systems, traffic lights, or additional safety components.

The **V-Barrier-5m-Fix** therefore offers the ideal combination of compact design, robust construction and practical ease of use – ensuring clear processes and maximum security wherever reliable access control is required.

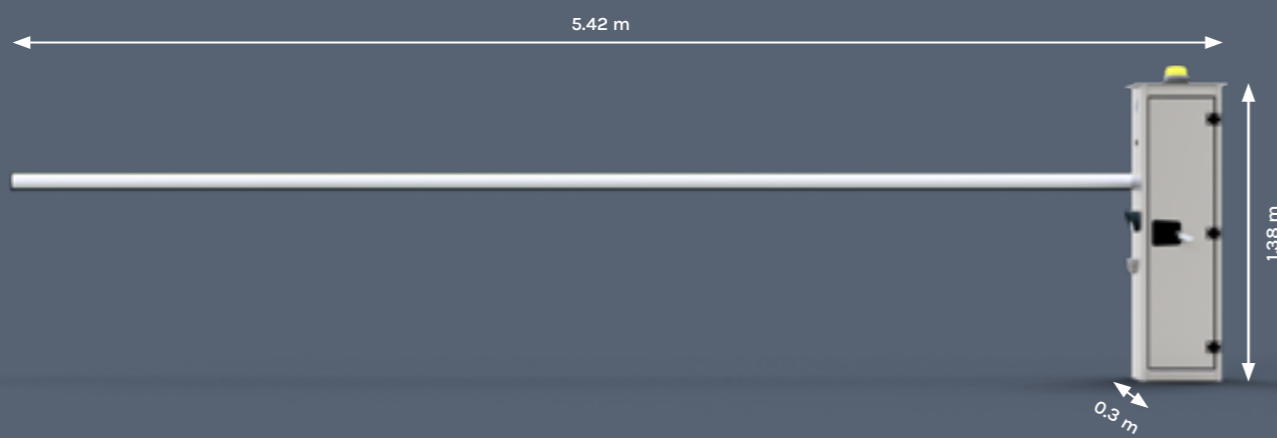

### Outstanding features: Discover the highlights of the V-Barrier-5m-Fix:

- ✓ Dimensions: 0.3 x 5.42 x 1.38 m
- ✓ Weight: 65 kg
- ✓ Passage width: 4.75 m / can be shortened to 2.75 m
- ✓ Suitable for outdoor use
- ✓ For dowelling
- ✓ Connection via 230 V CEE plug
- ✓ 24 V drive
- ✓ Opening time 3.5 – 6 s
- ✓ Suitable for intensive use
- ✓ Integration of many accessories (access control, induction loop, traffic lights)
- ✓ Light barrier
- ✓ Optional pendulum support and support post
- ✓ Automatic closing adjustable (20 s as standard)
- ✓ Includes 2 hand-held transmitters
- ✓ Manual operation can be activated with a key
- ✓ Individual powder coating

Product group	Item description	Part-No.	kg
Barrier 5m-Fix, left	V-Barrier-5m-Fix, left-hand closing	VPBA5F	65.00
Barrier 5m-Fix, left with Laser	V-Barrier-5m-Fix-Laser, left-hand closing	VPBA5FL	65.00
Barrier 5m-Fix, right	V-Barrier-5m-Fix, right-hand closing	VPBA5FR	65.00
Barrier 5m-Fix, right with Laser	V-Barrier-5m-Fix-Laser, right-hand closing	VPBA5FRL	65.00
Support post	Support post with small platform	VZSAUF	6.50
Support post	Support posts for barriers, fixed variants	VZSAUFF	6.50



Accessories	Item description	Part-No.	kg
Small surface finish	RAL colour of choice - size S (Barrier)	VRALW-S	
Very small surface finish	RAL colour of choice - size XS (Support post)	VRALW-XS	
Access control	Access control with 1 reader	VB-ZUKO1	5.00
Access control	Mounting access control with 1 reader	VB-ZUKO1-M	
Access control	Wiring customer access systems	VZIWIRE	
Gate / barrier accessories	Retro-reflective photocell	VZTRLIS	0.20
Gate / barrier accessories	Reflector for reflective light barrier	VZSREF	0.08
Barrier accessories	Suspended grid, 2 m element	VZSHANG	4.00
Barrier accessories	Brace for the housing, when installed with a support post.	VZSHANG1	0.40
Barrier accessories	Brace for pendulum support, when no support post is used	VZSHANG2	0.11
Barrier accessories	Installation of suspended grille (per barrier)	VZSHANG-M	
Barrier accessories	Swing support	VZSPEND	15.00
Barrier accessories	Swing support for fixed variants	VZSPENDF	0.32
Barrier accessories	Mounting the pendulum support	VZSPEND-M	
Barrier accessories	Single-channel magnetic loop detector	VZSDT1	1.00
Barrier accessories	Two-channel magnetic loop detector	VZSDT2	1.00
Barrier accessories	Magnetic loop with 6 m connection cable	VZSMAG6	1.00
Barrier accessories	Magnetic loop with 10 m connection cable	VZSMAG10	1.00
Barrier accessories	Mounting magnetic loop	VZSMAG-M	
Barrier accessories	Shortenable LED for 5 m barrier boom	VZSLED5	0.10
Barrier accessories	Shortening the barrier beams	VZSKURZ	
Barrier accessories	Circuit board for synchronised operation of 2x barriers (1x circuit board required per barrier)	VZSSYN	0.01
Barrier accessories	Circuit board for synchronised operation of 2 barriers Installation (Wiring of 2 barriers + testing)	VZSSYN-M	
Barrier accessories	Traffic light control	VZSAMP	1.00
Barrier accessories	Assembly traffic light control	VZSAMP-M	
Barrier accessories	Traffic light	VZSAMP	1.00
Barrier accessories	Installation of traffic light incl. device on barrier platform	VZSAMP-M	
Barrier accessories	Laser scanner with remote control and fixture incl. screws	VZSLAS	0.10
Barrier accessories	Handheld transmitter	VZSREM	0.01
Barrier accessories	Barrier boom 5 m	VZSSB5	
Barrier accessories	Motor + motor control unit for Barrier-5m	VZSMOT5	10.00
Barrier accessories	4-channel hand-held transmitter	VZSREM4	0.02
Barrier accessories	Laser aperture field	VZSLAS-OF	7.30
Barrier accessories	Barrier foundation plate	VZSFP	0.50
Barrier accessories	LED	VZSLED	0.80
IoT	LTE call module	VZELTE	0.20
IoT	Mounting LTE module	VZELTE-M	

# V-Barrier-7m-Fix

## heavy-duty access control – reliable, secure and built for continuous operation.

The **V-Barrier-7m-Fix** is the ideal solution for secure and controlled vehicle access. Manufactured from robust, galvanized steel, it offers a durable and resilient construction – perfect for daily outdoor operation.

Thanks to its reliable electric control system, the barrier opens and closes quickly and smoothly. The generous barrier width allows comfortable passage even for larger vehicles and can be flexibly adapted to different application areas.

With its fixed installation, the **V-Barrier-7m-Fix** provides high stability and is ideally suited for heavily frequented access points. Various accessory options – such as access control systems, traffic lights, or additional safety components – can be easily integrated to expand its range of applications.

Whether on construction sites, industrial yards, or event areas, the **V-Barrier-7m-Fix** ensures clear processes, enhanced security and smooth access management.

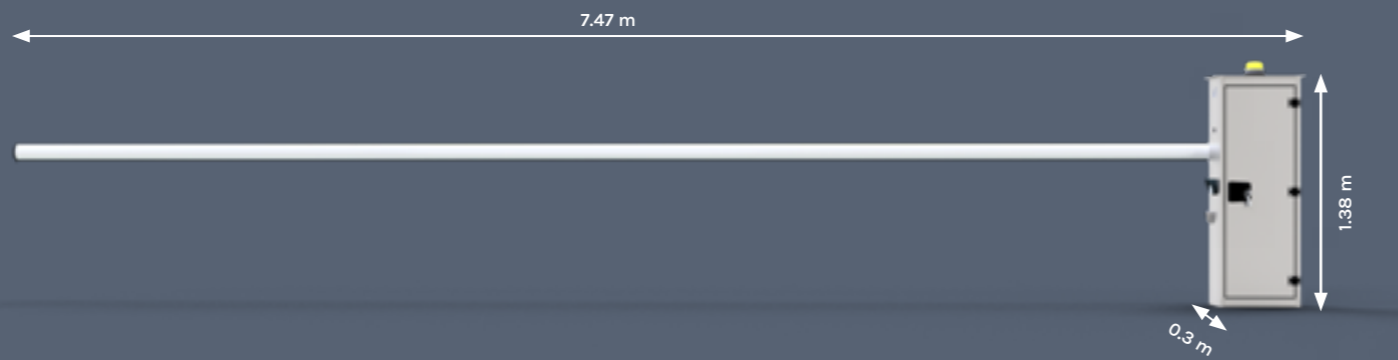

### Outstanding features: Discover the highlights of the V-Barrier-7m-Fix:

- ✓ Dimensions: 0.3 x 7.47 x 1.38 m
- ✓ Weight: 85 kg
- ✓ Passage width: 6.70 m / can be shortened to 4.70 m
- ✓ Suitable for outdoor use
- ✓ For dowelling
- ✓ Connection via 230 V CEE plug
- ✓ 24 V drive
- ✓ Opening time 3.5 – 6 s
- ✓ Suitable for intensive use
- ✓ Integration of many accessories (access control, induction loop, traffic lights)
- ✓ Light barrier
- ✓ Optional pendulum support and support post
- ✓ Automatic closing adjustable (20 s as standard)
- ✓ Includes 2 hand-held transmitters
- ✓ Manual operation can be activated with a key
- ✓ Individual powder coating

Product group	Item description	Part-No.	kg
Barrier 7m-Fix, left	V-Barrier-7m-Fix, left-hand closing	VPBA7F	85.00
Barrier 7m-Fix, left with Laser	V-Barrier-7m-Fix-Laser, left-hand closing	VPBA7FL	85.00
Barrier 7m-Fix, right	V-Barrier-7m-Fix, right-hand closing	VPBA7FR	85.00
Barrier 7m-Fix, right with Laser	V-Barrier-7m-Fix-Laser, right-hand closing	VPBA7FRL	85.00
Support post	Support post with small platform	VZSAUF	6.50
Support post	Support posts for barriers, fixed variants	VZSAUFF	6.50

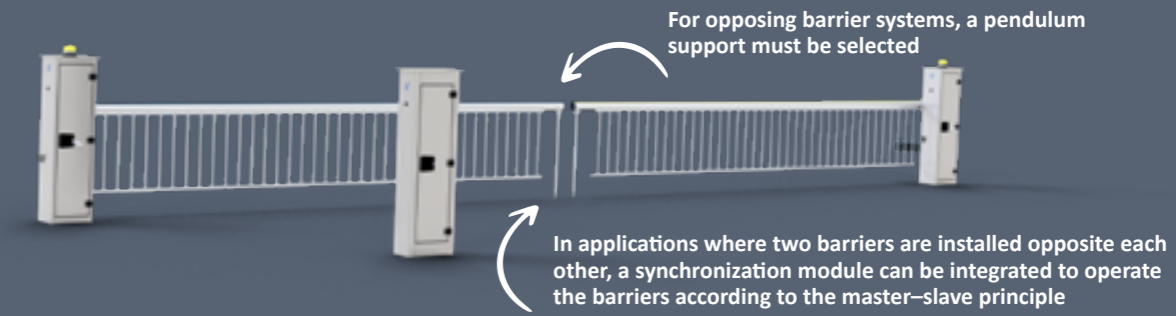

Accessories	Item description	Part-No.	kg
Small surface finish	RAL colour of choice - size S (Barrier)	VRALW-S	
Very small surface finish	RAL colour of choice - size XS (Support post)	VRALW-XS	
Access control	Access control with 1 reader	VB-ZUKO1	5.00
Access control	Mounting access control with 1 reader	VB-ZUKO1-M	
Access control	Wiring customer access systems	VZIWIRE	
Gate / barrier accessories	Retro-reflective photocell	VZTRLIS	0.20
Gate / barrier accessories	Reflector for reflective light barrier	VZSREF	0.08
Barrier accessories	Suspended grid, 2 m element	VZSHANG	4.00
Barrier accessories	Brace for the housing, when installed with a support post.	VZSHANG1	0.40
Barrier accessories	Brace for pendulum support, when no support post is used	VZSHANG2	0.11
Barrier accessories	Installation of suspended grille (per barrier)	VZSHANG-M	
Barrier accessories	Swing support	VZSPEND	15.00
Barrier accessories	Swing support for fixed variants	VZSPENDF	0.32
Barrier accessories	Mounting the pendulum support	VZSPEND-M	
Barrier accessories	Single-channel magnetic loop detector	VZSDET1	1.00
Barrier accessories	Two-channel magnetic loop detector	VZSDET2	1.00
Barrier accessories	Magnetic loop with 6 m connection cable	VZSMAG6	1.00
Barrier accessories	Magnetic loop with 10 m connection cable	VZSMAG10	1.00
Barrier accessories	Mounting magnetic loop	VZSMAG-M	
Barrier accessories	Spring for barrier-7m	VZSFED	2,00
Barrier accessories	Installation of the small spring for the barrier-7m	VZSFED-M	
Barrier accessories	Shortenable LED for 8 m barrier boom	VZSLED8	0,10
Barrier accessories	Shortening the barrier beams	VZSKURZ	
Barrier accessories	Circuit board for synchronised operation of 2x barriers (1x circuit board required per barrier)	VZSSYN	0.01
Barrier accessories	Circuit board for synchronised operation of 2 barriers Installation (Wiring of 2 barriers + testing)	VZSSYN-M	
Barrier accessories	Traffic light control	VZSAMPS	1.00
Barrier accessories	Assembly traffic light control	VZSAMPS-M	
Barrier accessories	Traffic light	VZSAMP	1.00
Barrier accessories	Installation of traffic light incl. device on barrier platform	VZSAMP-M	
Barrier accessories	Laser scanner with remote control and fixture incl. screws	VZSLAS	0.10
Barrier accessories	Handheld transmitter	VZSREM	0.01
Barrier accessories	Barrier boom 7 m	VZSSB7	15,3
Barrier accessories	Motor + motor control unit for Barrier-7m	VZSMOT7	10,00
Barrier accessories	4-channel hand-held transmitter	VZSREM4	0.02
Barrier accessories	Laser aperture field	VZSLAS-OF	7.30
Barrier accessories	Barrier foundation plate	VZSFP	0.50
Barrier accessories	LED	VZSLED	0.80
IoT	LTE call module	VZELTE	0.20
IoT	Mounting LTE module	VZELTE-M	

# For smooth and clearly organized access procedures.

## V-Control – the smart addition to any access solution.

With the V-Control registration pedestal, we offer the ideal solution for structured and secure access control on construction sites, at events, or in temporary security areas.

Manufactured from galvanized steel and mounted on a mobile concrete platform, both models stand out for their stability, durability and ease of use. Both versions can be flexibly combined – as a standalone registration station or in conjunction with barriers, turnstiles and gate systems. This creates a well-designed access system that combines functionality, security and mobility.

For use in demanding environments.



# Smart control – compact and robust.

## The ideal addition to V-Gate and V-Barrier.

The **V-Control** is the perfect addition to our V-Gate and V-Barrier systems, serving as a central operating and control point for a wide range of access solutions. Whether on construction sites, industrial premises, or temporary security zones, the pedestal creates a clearly structured access point that can be flexibly adapted to different requirements.

Mounted on a mobile concrete platform with leveling feet, the **V-Control** is ready for immediate use and can be positioned with minimal effort. Its galvanized steel construction ensures high resistance for outdoor use, making the pedestal ideal for both permanent and changing locations.

With its spacious interior and lockable service hatch, the **V-Control** provides ample room for additional components. Upon request, it can be expanded with access control systems, readers, or other modules and easily connected to barriers or gate systems. Power is conveniently supplied via a 230 V connection, ensuring a particularly straightforward installation.



**Outstanding features: Discover the highlights of the V-Control:**

- ✓ Dimensions: 0.50 × 1.00 × 1.50 m (0.50 × 1.00 × 2.30 m)
- ✓ Weight: 175 kg
- ✓ Suitable for outdoor use
- ✓ On mobile concrete platform with adjustable feet
- ✓ Connection via 230 V CEE plug
- ✓ Expandable with access control
- ✓ Can be connected to barrier, gate, etc.
- ✓ Lockable service flap
- ✓ Custom powder coating

Product group	Item description	Part-No.	kg
Registration systems	V-Control	VPCO	175.00
Registration systems	V-Control-Fix	VPCOF	40.00
Registration systems	V-Control-Long	VPCOL	54.00
Registration systems	V-Control-Long-Fix	VPCOLF	54.00

Accessories	Item description	Part-No.	kg
Small surface finish	RAL colour of choice - size S	VRALW-S	
Access control	Access control with 1 reader	VB-ZUKO1	5.00
Access control	Mounting access control with 1 reader	VB-ZUKO1-M	
Access control	Access control with 2 readers	VB-ZUKO2	5.00
Access control	Mounting access control with 2 readers	VB-ZUKO2-M	
Access control	Login terminal	VB-ZUKOA	2.00
Access control	Assembly of logon terminal	VB-ZUKOA-M	
Access control	Preparation of the V-Control for customer-supplied systems (CEE plug, empty enclosure, fuses, etc.)	VZZCON	6.50
Access control	Wiring customer access systems	VZIWIRES	

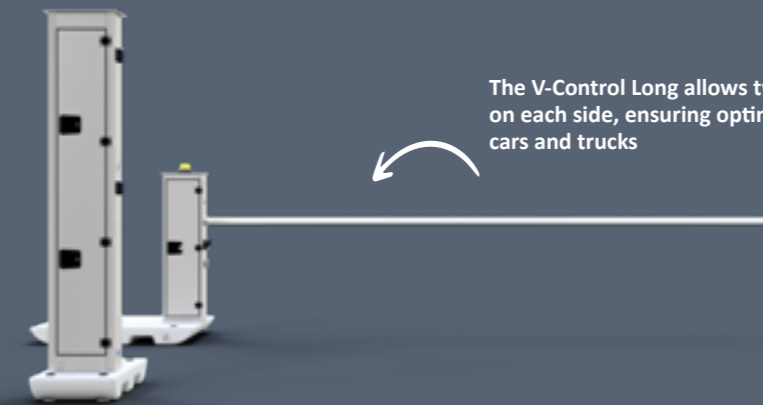

Product group	Item description	Part-No.	kg
Control Clock	V-Control-Clock	VPCOC	8.00

Accessories	Item description	Part-No.	kg
Access control	Clock	VB-ZUKOC	5.00
Access control	Clock installation	VB-ZUKOC-M	
Access control	Wiring customer access systems	VZIWIRES	



# Modern solutions for comprehensive security.

## Security that thinks ahead – for maximum control across any terrain.

Robust, flexible and intelligent – with our **V-Alert** security system, the construction fence alarm system, and **V-Post**, the lighting mast, we ensure reliable protection on construction sites and at events. Featuring modern monitoring functions, a durable design and easy integration, they deliver top-level security wherever it is needed.

### Modern security systems in operation.

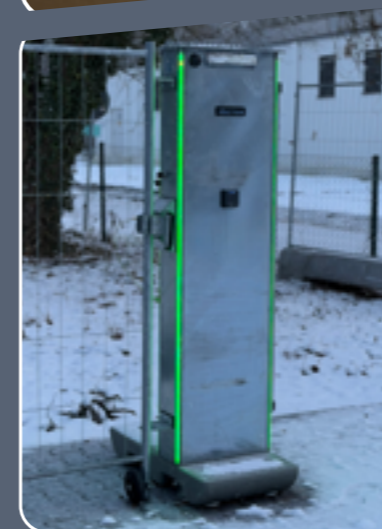

# V-Alert – mobile construction fence alarm system! More protection for materials, terrain and team – anytime, anywhere.

The **V-Alert** provides reliable protection for construction sites, storage areas and temporary security zones. As a mobile alarm system, it detects intrusion attempts at an early stage and instantly sends push notifications via the app.

The system is mounted on a mobile concrete platform and ready for immediate use – without the need for permanent installation. Its galvanized steel construction makes the **V-Alert** robust and weather-resistant. Visible LED strips, a siren and an electric lock for securing the adjacent construction fence gate provide clear signals and enhanced security.

The **V-Alert** can be flexibly integrated into fence systems and combined with access control solutions on both sides. For a consistent appearance, custom powder coating is also available.



### Outstanding features: Discover the highlights of the V-Alert:

- ✓ Dimensions: 0.71 x 1.00 x 2.03 m
- ✓ Weight: 224 kg
- ✓ On mobile concrete platform with adjustable feet
- ✓ Suitable for outdoor use
- ✓ Connection via 230 V CEE plug
- ✓ Resistance measurement for detection of break-in attempts
- ✓ Electric lock for locking the adjacent construction fence door
- ✓ LED strips as status indicator
- ✓ Siren for alarm
- ✓ Control via app
- ✓ Alarms via push notification
- ✓ Connection of access controls on both sides possible
- ✓ Flexible fence connection
- ✓ Individual powder coating

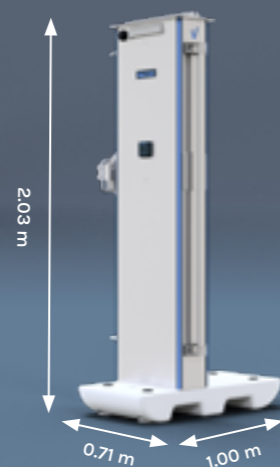

Product group	Item description	Part-No.	kg
Security systems	V-Alert, left-hand version	VPAS	224.00
Security systems	V-Alert, right-hand version	VPASR	224.00

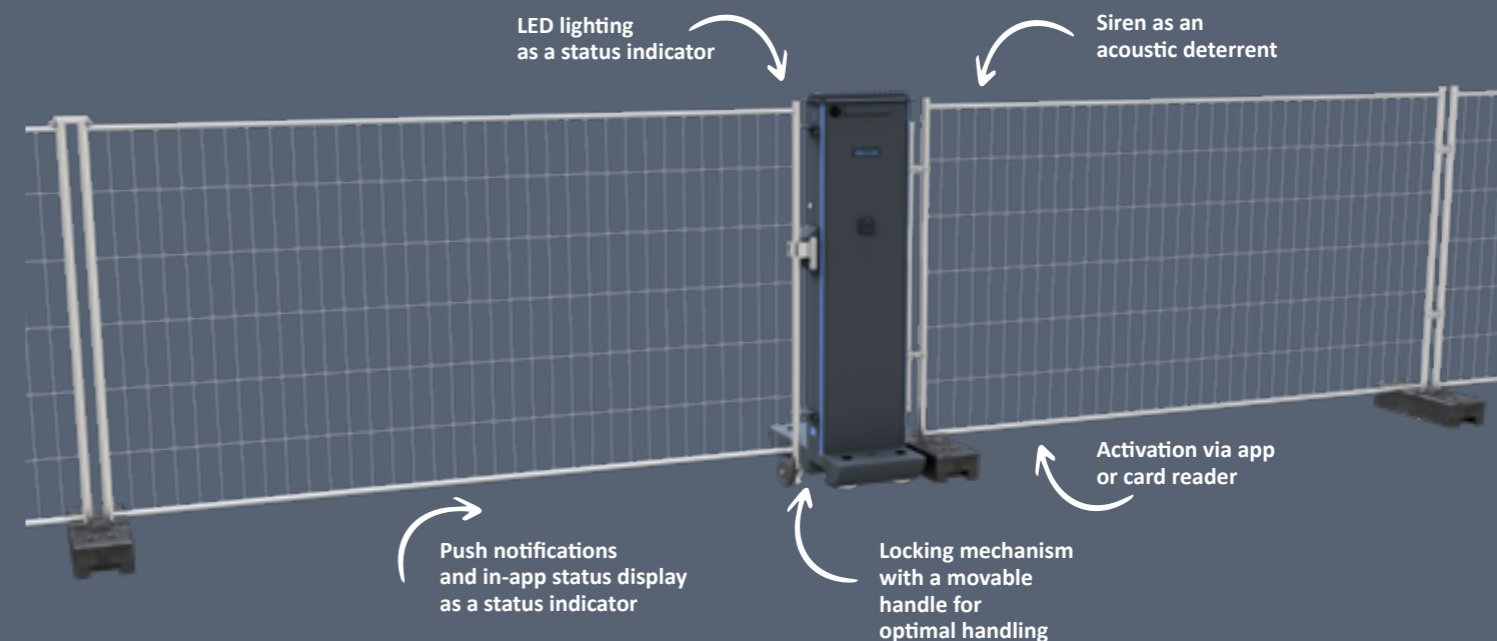

Accessories	Item description	Part-No.	kg
Small surface finish	RAL colour of choice - size S	VRALW-S	
Accessories security systems	Power supply LED 5 V / 60 A	VZANET5.60	0.22
Accessories security systems	Power supply 5 V / 2.4 A	VZANET5	0.22
Accessories security systems	Power supply unit 12 V / 4.5 A	VZANET12	0.40
Accessories security systems	Siren	VZASIR	0.40
Accessories security systems	Attachments, left-hand version	VZALINKS	3.70
Accessories security systems	Attachments, right-hand version	VZARECHTS	3.70
Accessories security systems	Construction fence hinge	VZASCHAR	0.80
Accessories security systems	Insulation construction fence module	VZAIISO	0.20
Accessories security systems	Lock insulation	VZAIISO2	0.20
Accessories security systems	Lock	VZASCHLOSS	1.00
Accessories security systems	Handle, left-hand version	VZAGRIFFF	1.50
Accessories security systems	Handle, right-hand version	VZAGRIFFR	1.50
Accessories security systems	LED strip 1x	VZALED	0.08
Accessories security systems	LED housing	VZALEDG	0.20

# Practical, flexible, stylish, functional & fantastic.



## Discover the variety of our cubes as your exclusive retreat.

Welcome to a world of limitless possibilities for **construction and eventcubes!**

Our innovative range of cubes has been developed to meet your demands for flexible design, functionality and aesthetics. From the stylish **V-Lounge** and the practical **V-Office** to the versatile **V-Space** and the reliable **V-Guard**, our cubes provide the ideal solution for a wide variety of applications.

Step into the world of the **V-Lounge** – a luxurious retreat designed for both events and private use. With its modern design and high-quality materials, the **V-Lounge** creates a welcoming atmosphere for guests and visitors.

The **V-Office** offers a flexible working environment that integrates seamlessly into any event or construction project. With its smart spatial concept and premium features, the **V-Office** is the perfect place for efficient work and creative collaboration.

The **V-Space** is a transformable unit that adapts to the changing requirements of your event or construction site. With its modular structure and versatile applications, the **V-Space** is the ideal solution for customized layouts and maximum flexibility.

Last but certainly not least, the **V-Guard** – your reliable partner for safety and security. With its robust construction and innovative security features, the **V-Guard** provides the perfect solution for safeguarding events and construction projects.

Discover our cubes and be inspired by their versatility and functionality. With our high-quality products, there are no limits to your creativity – whether you are planning an event or bringing a construction project to life.

V-Lounge



V-Office



V-Space



V-Guard



Turnstiles  
Gates  
Doors  
Barriers  
Registration systems  
Security systems  
Room systems  
Extensions  
Software

Turnstiles  
Gates  
Doors  
Barriers  
Registration systems  
Security systems  
Room systems  
Extensions  
Software

# Enjoy luxury anywhere: The V-Lounge – your premium mobile lounge space.

Welcome to the **V-Lounge** – the exclusive mobile lounge space for spontaneous meetings. With its modern design and versatile functionality, the V-Lounge provides the ideal setting for brief meetings or moments of relaxation.

Thanks to integrated forklift pockets and crane eyes, the **V-Lounge** can be easily repositioned and used both as a mobile and stationary solution. Its generous dimensions of 2.00 x 2.00 x 2.41 m offer ample space for comfort and relaxation, while the moderate weight of 1559 kg ensures easy handling.

The **V-Lounge's** features leave nothing to be desired: a printed aluminum composite panel serves as a stylish back wall, while three bar stools and a sanitizer dispenser ensure comfort and hygiene. An ashtray is also included. Equipped with a CEE plug, LED panel and Schuko sockets, the **V-Lounge** provides all the amenities needed for a pleasant atmosphere.

Experience luxury and comfort in every situation with the **V-Lounge** – whether at work or during leisure time.



### Outstanding features: Discover the highlights of the V-Lounge:

- ✓ Dimensions: 2.00 x 2.00 x 2.41 m
- ✓ Weight: 1559 kg
- ✓ Entrance width: 1.79 m
- ✓ Suitable for outdoor use
- ✓ On mobile concrete platform with adjustable feet
- ✓ Connection via 230 V CEE plug
- ✓ Lockable service flap
- ✓ LED lighting
- ✓ Disinfectant dispenser
- ✓ Ashtray
- ✓ 3x bar stools
- ✓ Schuko sockets + light switch

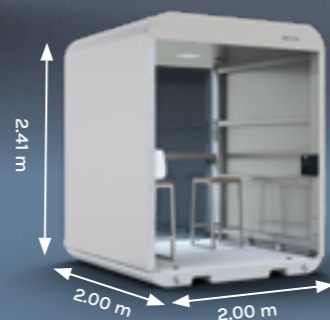

# Discover the possibilities: Enhance your V-Lounge with our extensive range of accessories.

Product group	Item description	Part-No.	kg
Lounge	V-Lounge	VPLO	1559.00

Choose from a wide range of color options. From vibrant shades to subtle tones – let your creativity run free and design your space exactly the way you envision it. Our modular room systems can be individually powder-coated in your preferred color to perfectly match your design concept

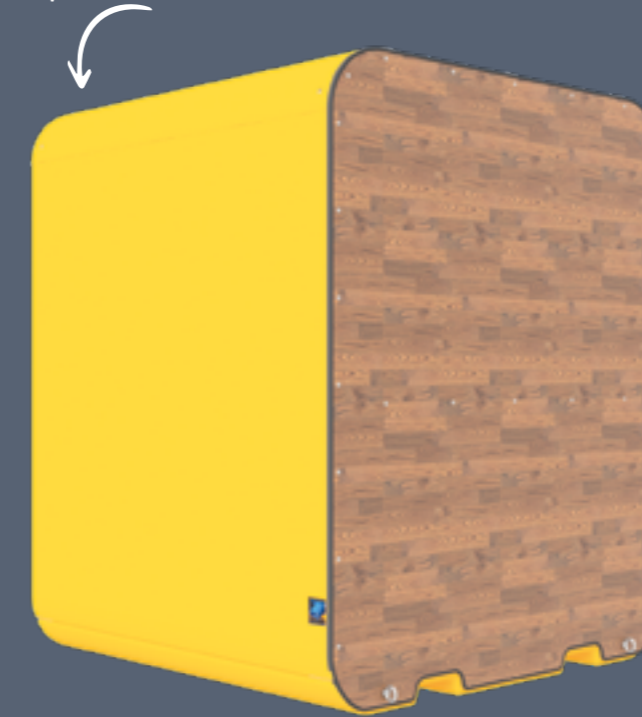

Add a unique touch to your spaces – our aluminum composite panel can be custom printed to bring your creative ideas to life

Accessories	Item description	Part-No.	kg
Large surface finish	RAL colour of choice - size L	VRALW-L	
Accessories Room systems	Bar stools	VZRBAR	11.07
Accessories Room systems	Fire protection kit	VZRBRA	3.14
Accessories Room systems	Ashtray	VZRASB	2.98
Accessories Room systems	Aluminium composite panel	VZRALVPL	17.70
Accessories Room systems	Gas pressure damper for large bonnet	VZRGDG	0.25
Accessories Room systems	Disinfectant dispenser, incl. disinfectant	VZRDES	1.00
Accessories Room systems	LED for room systems	VZRLED	1.00
Customization	Customised printing of Dibond panels	VZIPRINT	

# More than just an office: The V-Office creates space for creativity and productivity.

The **V-Office** gives you the opportunity to carry out your office work in a quiet and protected environment – whether on construction sites or in production facilities.

With its innovative design and practical features, the **V-Office** can be used as a mobile unit or installed permanently. Thanks to integrated forklift pockets and crane lifting lugs, it can be easily repositioned and flexibly adapted to your requirements.

Its generous dimensions of 2.00 × 2.00 × 2.41 m provide ample space for comfort and efficiency, while the moderate weight of 1644 kg ensures easy handling.

The high-quality equipment leaves nothing to be desired: featuring a CEE plug, polycarbonate panels as front and rear walls with a glass door, a writable heating panel, a height-adjustable desk, an LED panel and Schuko sockets, the **V-Office** offers all the amenities of a modern workspace.



### Outstanding features: Discover the highlights of the V-Office:

- ✓ Dimensions: 2.00 x 2.00 x 2.41 m
- ✓ Weight: 1644 kg
- ✓ Entrance width: 0.84 m
- ✓ Suitable for outdoor use
- ✓ On mobile concrete platform with adjustable feet
- ✓ Connection via 230 V CEE plug
- ✓ Lockable service flap
- ✓ LED lighting
- ✓ Height-adjustable table
- ✓ Infrared heating
- ✓ Door
- ✓ Schuko sockets + light switch

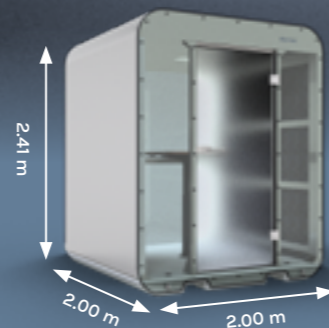

Product group	Item description	Part-No.	kg
Office	V-Office	VPOF	1644.00

## The perfect combination of functionality, comfort and style for your mobile office experience.



The **V-Office** not only provides an efficient workspace. We are also able to implement individual customer requirements, such as setting up a podcast lounge, as realized in this custom project. In addition, the **V-Office** is equipped with a heating panel to maximize comfort while working.

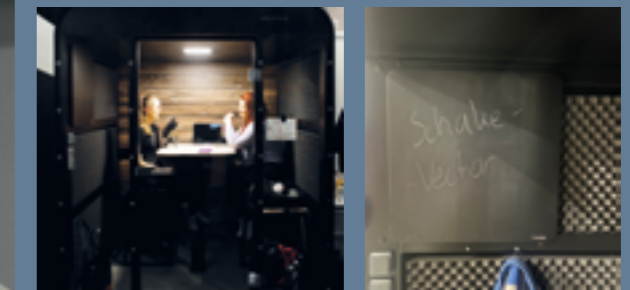

Height-adjustable desks offer the flexibility to adapt the height of the workspace, promoting an ergonomic working environment and increasing productivity. At the touch of a button, users can switch between sitting and standing to reduce physical strain and support a healthier way of working



Accessories	Item description	Part-No.	kg
Large surface finish	RAL colour of choice - size L	VRALW-L	
Accessories Room systems	height adjustable table	VZRTIS	22.57
Accessories Room systems	Wooden table top	VZRTIP	10.02
Accessories Room systems	Fire protection kit	VZRBRA	3.14
Accessories Room systems	Aluminium composite panel	VZRALVPL	17.70
Accessories Room systems	Polycarbonate rear window	VZRPOHS	23.93
Accessories Room systems	Polycarbonate windscreen	VZRPOFS	15.02
Accessories Room systems	Lockable door	VZRTUER	28.50
Accessories Room systems	Gas pressure damper for large bonnet	VZRGDG	0.25
Accessories Room systems	LED for room systems	VZRLED	1.00

# Create space for innovation: V-Space – your versatile companion for construction sites and events.

Experience the versatility of the **V-Space** – your mobile site cabin for optimized construction and event organization!

The **V-Space** redefines flexibility: it is perfectly suited for use on construction sites and at events and can easily be used as an open office or meeting point. Thanks to integrated forklift pockets and crane eyes, it can be effortlessly repositioned – whether as a mobile or stationary solution.

With dimensions of 2.00 x 2.00 x 2.41 m and a weight of 1575 kg, the **V-Space** offers the ideal balance between portability and robustness. It is delivered fully equipped, including a wooden table, shelving unit, polycarbonate panel, CEE plug, LED panel and Schuko sockets.

Step into a new dimension of workspace design and simplify your projects with the **V-Space** – the epitome of functionality and style.



**Outstanding features: Discover the highlights of the V-Space:**

- ✓ Dimensions: 2.00 x 2.00 x 2.41 m
- ✓ Weight: 1575 kg
- ✓ Entrance width: 1.79 m
- ✓ Suitable for outdoor use
- ✓ On mobile concrete platform with adjustable feet
- ✓ Connection via 230 V CEE plug
- ✓ Lockable service flap
- ✓ LED lighting
- ✓ Table
- ✓ Shelving system
- ✓ Schuko sockets + light switch

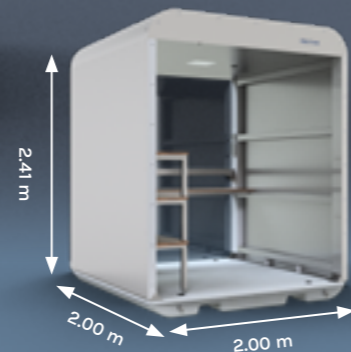

Product group	Item description	Part-No.	kg
Site cabin	V-Space	VPSP	1575.00

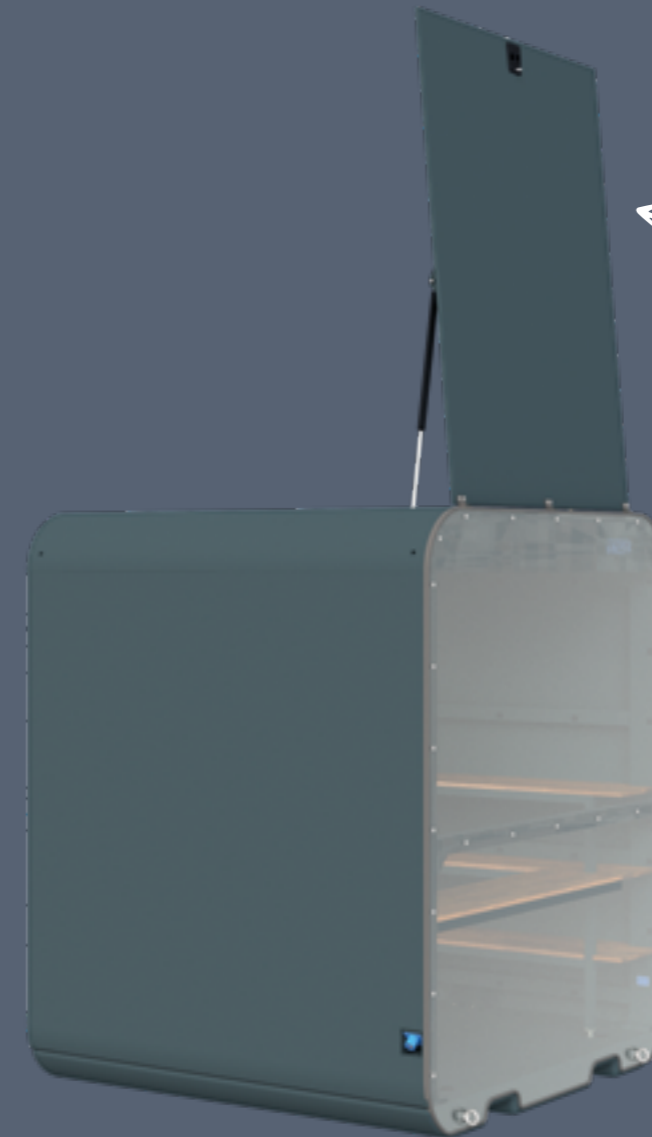

Discover our service hatch for maintenance work – an essential feature in all our modular room systems. Equipped with a gas strut and a lockable mechanism, it provides convenient access for inspections and repairs

The shelving system with wooden shelves offers an elegant way to organize your belongings.



Accessories	Item description	Part-No.	kg
Large surface finish	RAL colour of choice - size L	VRALW-L	
Accessories Room systems	Wooden shelf, bottom/centre	VZRREO	7.95
Accessories Room systems	Wooden shelf, bottom/centre	VZRREU	7.95
Accessories Room systems	Fire protection kit	VZRBRA	3.14
Accessories Room systems	Polycarbonate rear window	VZRPOHS	23.93
Accessories Room systems	Gas pressure damper for large bonnet	VZRGDG	0.25
Accessories Room systems	LED for room systems	VZRLED	1.00

# Security in focus: Discover the mobile protective tunnel V-Guard – a solution for every situation.

Discover the **V-Guard** – your mobile protective tunnel that not only guides pedestrian flow but also protects people from falling objects. Versatile in use and easily combinable with the V-Turnstile-Guard, the **V-Guard** offers maximum flexibility for a wide range of applications. Equipped with forklift pockets and crane eyes, it can be easily repositioned.

With compact dimensions of 2.00 × 2.00 × 2.41 m and a weight of 1485 kg, the **V-Guard** is an ideal solution for any environment. Optionally, it can be equipped with an LED panel controlled by a motion sensor to ensure maximum visibility and safety.

Experience the **V-Guard** as an innovative solution that makes your working environment safer and more efficient – whether on construction sites, at events or in other areas of application.

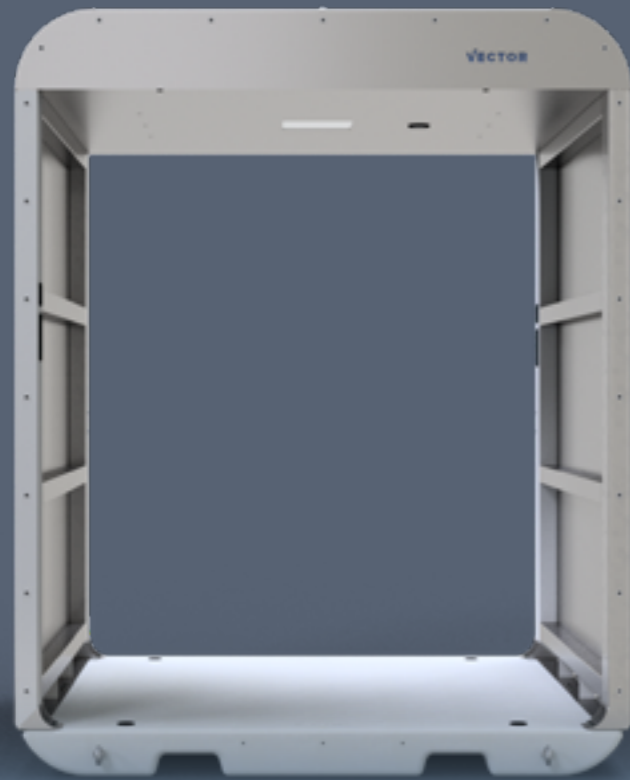

### Outstanding features: Discover the highlights of the V-Guard:

- ✓ Dimensions: 2.00 x 2.00 x 2.41 m
- ✓ Weight: 1485 kg
- ✓ Passage width: 1.79 mm
- ✓ Suitable for outdoor use
- ✓ On mobile concrete platform with adjustable feet
- ✓ Connection via 230 V CEE plug
- ✓ Lockable service flap
- ✓ Motion detector-controlled LED lighting

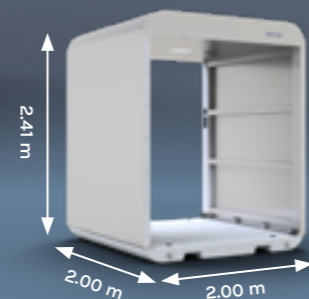

Product group	Item description	Part-No.	kg
Safety tunnel	V-Guard	VPTU	1485.00

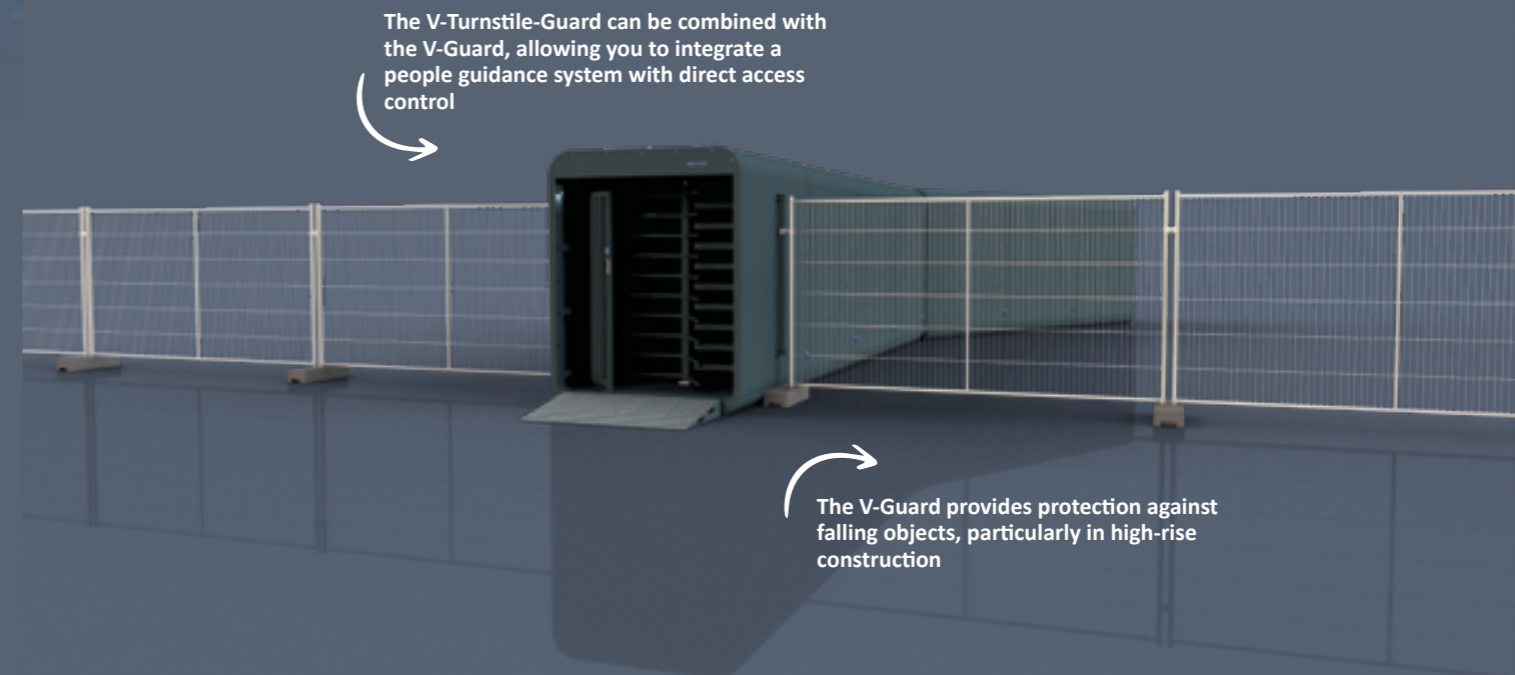

The V-Turnstile-Guard can be combined with the V-Guard, allowing you to integrate a people guidance system with direct access control

The V-Guard provides protection against falling objects, particularly in high-rise construction

Accessories	Item description	Part-No.	kg
Large surface finish	RAL colour of choice - size L	VRALW-L	
Accessories Room systems	LED for room systems	VZRLED	1.00
Accessories Room systems	Motion detector	VZRBEW	0.21
Accessories Room systems	Gas pressure damper for large bonnet	VZRGDG	0.25
Accessories Room systems	Joint profile for room system transition	VZRFP	1.14



All platforms are delivered with mounting components.

Product group	Item description	Part-No.	kg
Platform	V-Platform-large	VPPG	1000.00
Platform	V-Platform-medium for sliding gate	VPPM	1282.00
Platform	V-Platform-small for sliding gate	VPPK	130.00
Platform	V-Platform-compact for compact Varianten	VPPC	500.00

Accessories	Item description	Part-No.	kg
Very small surface finish	RAL colour of choice - size XS	VRALW-XS	
Platform accessories	Crane eye M16	VZPKRN	0.30
Platform accessories	Heavy-duty crane eye M16	VZPKRS	0.30
Platform accessories	Threaded feet, short	VZPGFK	1.70
Platform accessories	Threaded feet, long	VZPGFL	2.00
Platform accessories	Plug for threaded feet	VZPSTS	0.02

## Our exclusive collection of platforms - the perfect combination of style, functionality and versatility.

Our **V-Platforms** form the well-engineered foundation for all products in the platform series. With various dimensions and specifications, they are optimally tailored to the respective products.

For maximum flexibility and stability, our platforms feature adjustable feet that can be conveniently set from above. The mounting points offer high tensile strength and additional installation options. Removable crane eyes allow for easy crane handling, while the special anti-slip surface ensures safety in every situation. Transport your platform effortlessly using the integrated forklift pockets and achieve perfect alignment at all times thanks to the built-in spirit level. V-Ramps can be placed in front of the **V-Platforms** to prevent tripping hazards and the larger versions are also suitable for wheelchair users.

Whether permanently anchored into the ground as a solid foundation for long-term projects or used as a mobile platform for flexible applications – our platforms provide the ideal solution for demanding requirements. Discover the perfect platform for your next project!

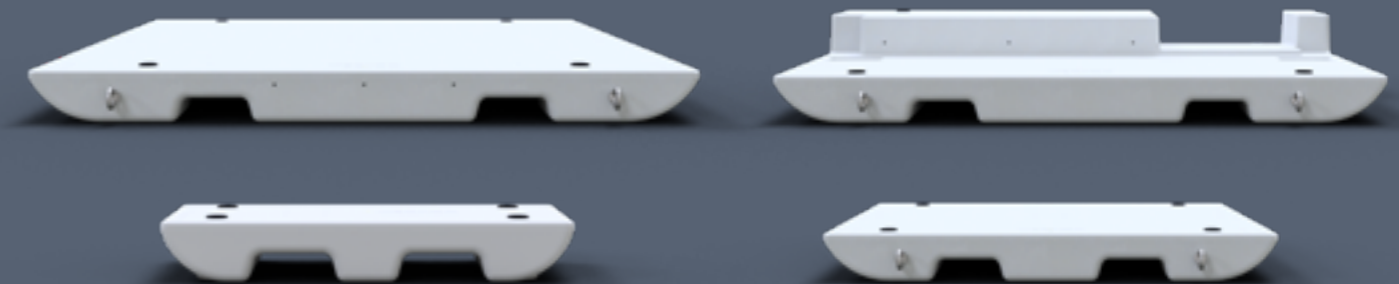

Product group	Item description	Part-No.	kg
Ramp	V-Ramp	VRAMPS	22,00
Ramp	V-Ramp-Long	VRAMPL	57,00

Accessories	Item description	Part-No.
Very small surface finish	RAL colour of choice - size XS	VRALW-XS

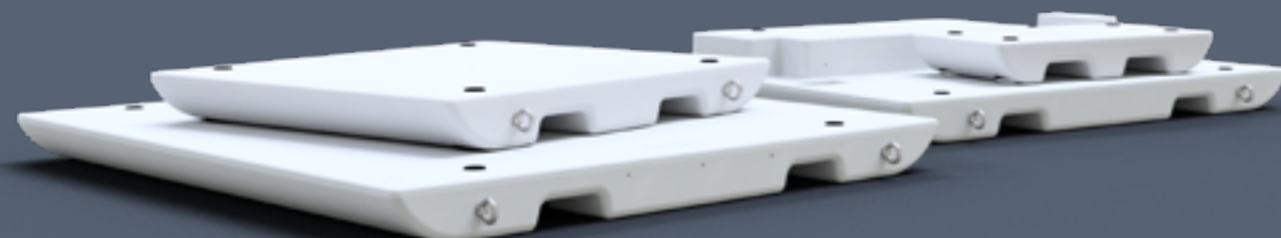
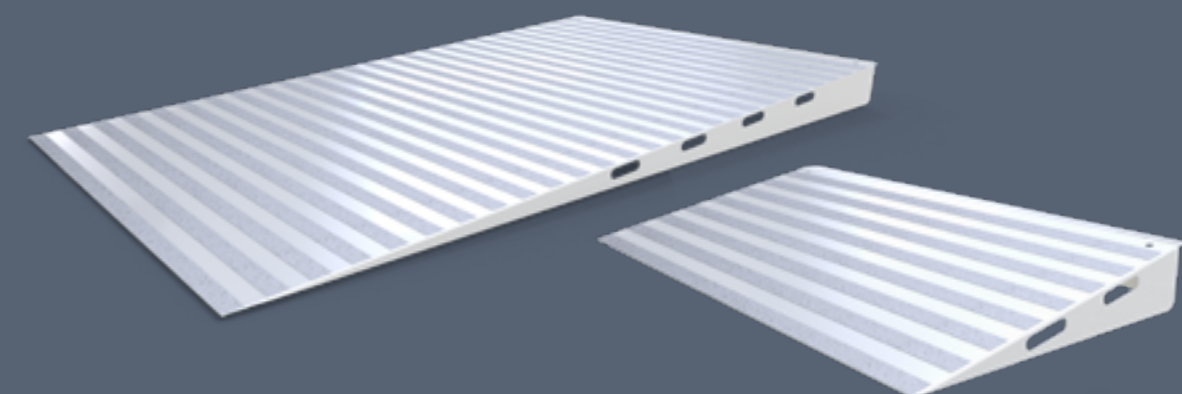

Turnstiles  
Gates  
Doors  
Barriers  
Registration systems  
Security systems  
Room systems  
Extensions  
Software

Turnstiles  
Gates  
Doors  
Barriers  
Registration systems  
Security systems  
Room systems  
Extensions  
Software

# Keep everything in view with the V-Connect app! Control, read out and manage your products centrally and intuitively.

With the new V-Connect app, you always stay in control of your Vector products. Whether operating devices or retrieving data, the app enables centralized and intuitive management.

Through a user-friendly interface, you can check the status of your devices in real time, adjust settings and access reports. Thanks to the seamless integration of all compatible products, managing your access solutions becomes more efficient and easier than ever before.

Experience smart technology that transforms your daily workflow – with V-Connect!



- ✓ LED control
- ✓ Resistance measurement
- ✓ Connection of readers via RS485 or Wiegand
- ✓ SMA connectors for external antennas
- ✓ SIM card slot

- ✓ Analog inputs and outputs
- ✓ Digital inputs and outputs
- ✓ 5 V power supply
- ✓ LEDs as status indicators



Product group	Item description	Part-No.	kg
Connect	IoT hardware including circuit board, housing and antenna	VC-IOT	0.27
Connect	Assembly of IoT hardware	VC-IOT-M	
Connect	V-Connect App monthly costs	VC-APP	



View status, control products



Turnstiles

Gates

Doors

Barriers

Registration systems

Security systems

Room systems

Extensions

Software

Turnstiles

Gates

Doors

Barriers

Registration systems

Security systems

Room systems

Extensions

Software

# Bausicht – the smart platform for access, documentation and logistics.

With **Bausicht**, you manage your construction site centrally, digitally and efficiently. From access control and document management to construction logistics, all processes are brought together on one platform and can be monitored in real time.

Automatic notifications for expiring documents, an intuitive user interface and multilingual operation make **Bausicht** a reliable tool for site managers, logistics coordinators and project stakeholders.

This way, you always stay in control, minimize liability risks and meet all legal requirements – simply, securely and without paperwork chaos.

Digital. Transparent. Efficient. – With **Bausicht**.

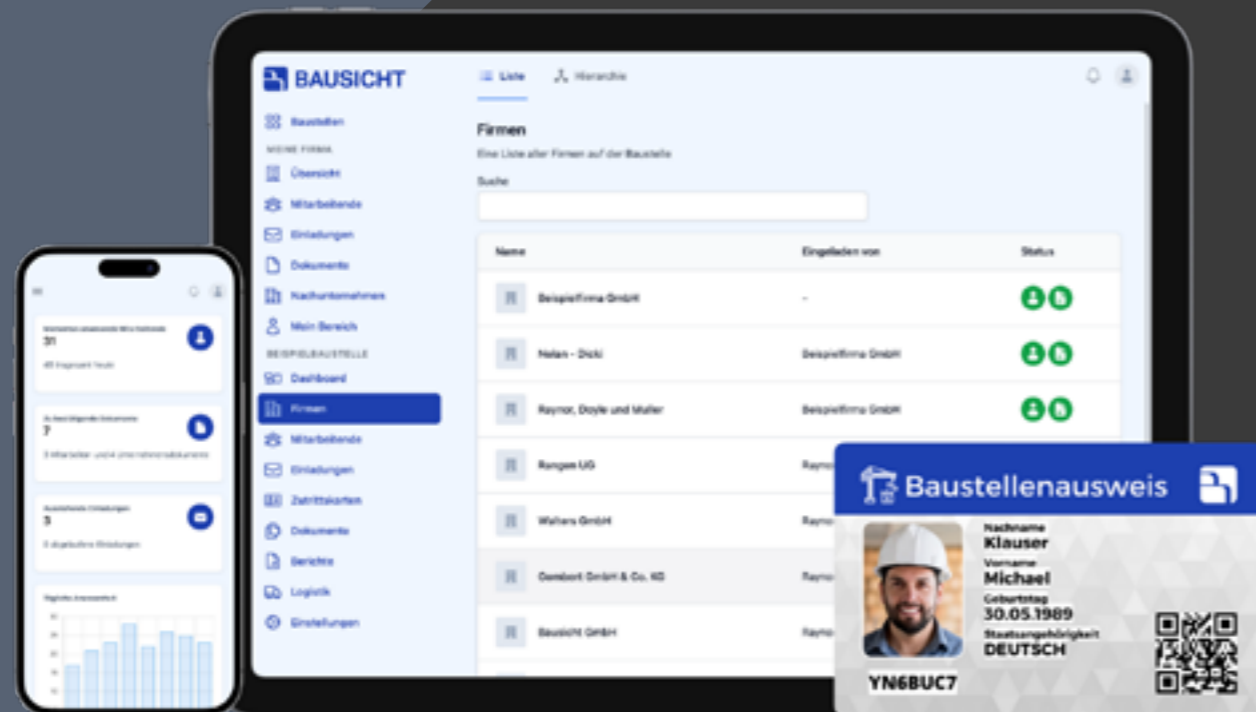

Product group	Item description	Part-No.
Software	Basic module - monthly	VBWEB-1
Software	Access control	VBWEB-2
Software	Document management - monthly	VBWEB-3
Software	Construction logistic- monthly	VBWEB-4

Product group	Item description	Part-No.	kg
Porter workplace	Webcam	VB-WEBCAM	1.00
Porter workplace	USB card reader	VB-USB-KARTENLESER	0.50
Porter workplace	USB cable	VB-USB-KABEL	0.02
Porter workplace	USB-Hub	VB-USB-HUB	0.02
Porter workplace	Ipad pen	VB-STIFT	0.02
Porter workplace	Ipad Protective cover	VB-SCHUTZHUELLE	0.02
Porter workplace	iPad	VB-IPAD	0.50
Porter workplace	Headset	VB-HEADSET	0.30
Porter workplace	Mini-Desktop	VB-PC	0.60
Porter workplace	Multiple socket outlet	VB-MEHRFACHSTECKDOSE	0.60
Porter workplace	Mousepad	VB-MAUSPAD	0.60
Printer	Cleaning card for printers	VB-REINIGUNGSKARTE	0.22
Printer	Printer cartridge	VB-DRUCKERPATRONE	0.50
Printer	Printer	VB-DRUCKER	0.50
Card	Mifare access card	VB-ZUTRITTSKARTE	0.22
Card	Card holder with clips	VB-KARTENHUELLE	0.30
Card	Construction site pass (card + card holder with clips)	VB-AUSWEIS	0.22
Set	Porter workplace	V-Pfoertner-Set	4.20
Set	Printer package	V-Drucker-Set	10.70
Set	Badge starter pack	V-Ausweis-Set	0.80

Product group	Item description	Part-No.	kg
Access control	Access control with 1 reader	VB-ZUKO1	5.00
Access control	Access control with 1 RFID4 reader	VB-ZUKO1-RFID4	5.00
Access control	Access control with 1 RFID10 reader	VB-ZUKO1-RFID10	5.00
Access control	Mounting access control with 1 reader	VB-ZUKO1-M	
Access control	Access control with 2 readers	VB-ZUKO2	5.00
Access control	Access control with 2 RFID4 readers	VB-ZUKO2-RFID4	5.00
Access control	Access control with 2 RFID10 readers	VB-ZUKO2-RFID10	5.00
Access control	Mounting access control with 2 readers	VB-ZUKO2-M	
Access control	Access control with 4 readers	VB-ZUKO4	5.00
Access control	Access control with 4 RFID4 readers	VB-ZUKO4-RFID4	5.50
Access control	Access control with 4 RFID10 readers	VB-ZUKO4-RFID10	5.50
Access control	Access control installation with 4 readers	VB-ZUKO4-M	
Access control	Login terminal	VB-ZUKOA	2.00
Access control	Assembly of login terminal	VB-ZUKOA-M	
Access control	Clock	VB-ZUKOC	2.00
Access control	Clock installation	VB-ZUKOC-M	
Access control	Router	VB-ROUTER	0.30
Access control	IO-Controller	VB-CONTROLLER	0.30
Access control	Switching power supply	VB-SCHALTNETZTEIL	0.22
Access control	RFID-Reader	VB-RFID-READER	0.22

Turnstiles

Gates

Doors

Barriers

Registration systems

Security systems

Room systems

Extensions

Software

Turnstiles

Gates

Doors

Barriers

Registration systems

Security systems

Room systems

Extensions

Software



**TRS**  
SOLUTIONS



**TRS Solutions**

---

Pilgatan 7  
564 35 Bankeryd  
[info@trssolutions.se](mailto:info@trssolutions.se)  
+46(70) 631 11 22

[www.trssolutions.se](http://www.trssolutions.se)